

Independent Urban Design Evidence

Prepared on behalf of City of Melbourne
Fishermans Bend Planning Review Panel



Prepared by
Koos de Keijzer
M.Arch, AIA

Table of Contents

1. Area of Expertise
2. Expertise to prepare this report
3. Background
4. Site Context
5. The need for a Framework Plan
6. Conclusion + Recommendations
8. References
9. Instructions

1. Area of Expertise

Architecture and Urban Design dealing with a range of project types including complex master planned communities, waterfront projects, mixed-use projects and housing.

2. Expertise to prepare this report

I hold the position of Principal at DKO Architecture. Prior to establishing DKO Architecture in 2000, I was a Director at HPA Architecture. DKO is a multi-award winning Architectural firm with offices in Auckland, Melbourne, Sydney and Ho Chi Minh. I am also a member of the Victorian Design Review Panel which provides independent advice to the state government about the design of significant development proposals. I hold a Masters Degree in Architecture and Urban Design from the Eindhoven University of Technology in the Netherlands. I am a registered Architect in Australia and New Zealand and am a member of the Architects Institute of Australia and New Zealand Institute of Architects, I have over 30 years' experience in designing and managing complex architecture and urban design projects in New Zealand, Australia, Netherlands and Southeast Asia. I was the masterplanner for HPA that led the Yarra's Edge Bid and Masterplan. I have recently completed masterplanning New Quay Central, Docklands and I am currently masterplanning New Quay West, Docklands.

3. Background

In December 2017 I was asked by the City of Melbourne if I was available to give evidence to the Fishermans Bend Planning Review Panel. I was given written instructions in January to review the Fishermans Bend Draft Framework and Planning Controls. I was also asked to comment on the Fishermans Bend Urban Design Strategy (Hodyl & Co, Sept 2017). I was asked to look at these documents with specific reference to the Lorimer Precinct.

I was asked to present my professional view of the role of Fishermans Bend in the context of city shaping and planning Melbourne's growth in the next 30 years. I was asked to outline specific local, national and international examples of urban renewal schemes that are predominantly in private ownership that have delivered good community infrastructure and quality design outcomes. I have visited the site. I have attached my brief in the appendix of this report.

Among other documents outlined later in my statement, I have reviewed:

- a. The draft Fishermans Bend Framework
- b. The proposed planning controls for GC81 (including the proposed DDO)
- c. The Hodyl and Co Urban Design Strategy September 2017
- d. Leanne Hodyl's statement of evidence and her addendum 2
- e. Adeline Pearson's 'Lorimer Built Form Testing and Capacity Modelling' report, March 2018.
- f. Donald Bates' evidence and addendum.
- g. Various submissions with specific reference to the Lorimer Precinct received after the exhibition of the amendment which were referred to me.

Declaration

I have made all the inquiries that I believe are desirable and appropriate and no matters of significance which I regard as relevant have to my knowledge been withheld from the Panel.

4. Site Context

The Fisherman's Bend precinct was rezoned to The Capital Cities Zone in 2012. There were no built form controls. The interim control GC 50 was introduced which still allows for buildings of significant height and bulk.

4.1 Lorimer + Interface

Lorimer Precinct

The Lorimer Precinct which is the emphasis of my report has the aspiration to be 'a vibrant, mixed use precinct close to the Yarra River and connected to Melbourne's CBD, Docklands and emerging renewal areas'.

The Westgate Freeway interface - is an acoustically loud interface and visually an eye sore along the precinct. This interface is also at the South side of the precinct - meaning there is no sun blocking issues. If higher storey tolerances are required within the precinct they should reside along this interface, to both block noise and the existing eye sore.

The Lorimer Street Interface - is one of the most aesthetically pleasing due to its close proximity to the water. The interface is on the north of the site and consequently strict height restrictions should apply to avoid blocking sunlight to the rest of the Precinct. The interface experiences moderate-to-high wind due to the waterfront location, and this should be addressed in the design process.

The Turner Street Green Reserve - is positioned in the middle of the site and has the potential to be the heart of activity within the precinct, if urban planning is carefully approached. With the planned Public Open Space (P.O.S.) along this interface it is important that natural sunlight is protected to make Turner Street an interactive area for the community to enjoy.

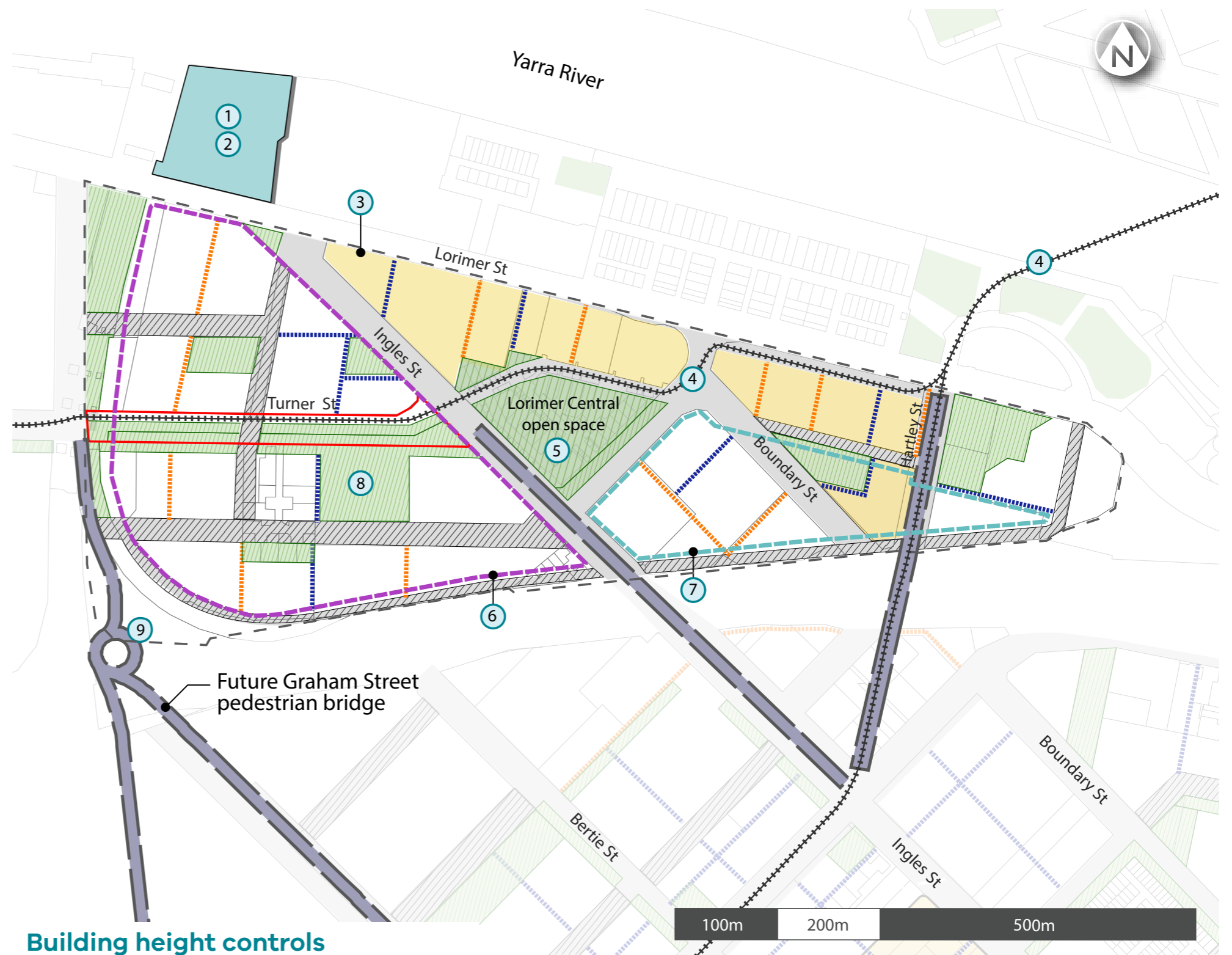

Building height controls



Figure 1

5. The need for a Framework Plan

There is no doubt amongst all the stakeholders that a long term strategic plan for the development of Fishermans Bend to 2050 is essential. With Melbourne's current and expected population growth, 480 hectares of land at Fisherman's Bend adjacent the CBD is an unparalleled opportunity. The draft Framework plan will provide direction in how the development of Fishermans Bend will be managed. Key elements of the draft controls include:

- the introduction of Floor Area Ratio's (FAR) and Floor Area Uplift (FAU) scheme.
- Height controls.
- Overshadowing controls to project public open space.
- Amending building setback controls.
- Minimum employment floorspace in designated core areas.
- Revised carparking controls and rates.
- Encouraging dwelling diversity and a range of building types.
- Water storage and reuse across buildings.
- Requiring new buildings to meeting a 4 Star Green Star rating.

These controls are important tools to ensure appropriate growth and development.

5.1 The proposed Fishermans Bend Planing Review Panel Draft Amendment GC81 Lorimer Precinct

The draft Framework plan also articulates a number of strategies and controls to guide the development. These cover some strategic assumptions such as population and employment assumptions. Floor Area Ratio's and Floor Area Uplift controls are introduced to provide some guidance on potential bulk on sites. In the Lorimer Precinct a FAR of 5.4 :1 and a minimum commercial FAR of 1.7:1 are suggested. Along with these controls are height and setback controls partially set out in schedule 67 to clause 43.02 DDO.

Objective 1.12 of the Framework Plan's sustainable goal 1 'a connected and livable community', the objective is to 'deliver a diverse range of housing choices including apartment towers, mid-rise and low-rise buildings, that suit a wide range of people and can be adapted to changing housing needs overtime'

Strategies 1.12.2 of the Framework plan states for Lorimer, 'a mix of mid-rise to high-rise housing including courtyard apartments and perimeter block developments as well as towers.'

While applauding these strategies it is unfortunate that a more descriptive city shaping vision has not been included. This vision could have had more visual controls and benchmarking controls about what the city might actually look like.

Lorimer Central with its community park and proposed tramway is an important corner stone of the Lorimer Precinct. It needs to be benchmarked visually and design drawings should be incorporated into the framework plan. Perhaps alternative typologies could also be provided.

The unfortunate result of these strategies is more of a high rise South Bank. The height controls intended for Lorimer in my opinion are reasonable but add little to the concept of Lorimer being a world-leading example of inner city renewal. With some sites having the opportunity for multiple towers above podiums, building separation should be a mandatory control. I would suggest adopting the NSW ADG controls on building separation.

I disagree with the proposition that a developer be allowed to build more floor area on a site above that mandated by the FAR. I think that the public benefit paradigm is hard to quantify and to manage. Community housing and facilities should be handled separately.

It is obvious from a Adeline Pearson's Capacity Modelling that the uplift is providing unfortunate outcomes. (Scenario 2B page 29 Lorimer Built Form Testing and Capacity Modelling March 2018).

The only uplift mechanism that I would be comfortable with is the design excellence approach where by holding a competition a developer may be awarded some uplift. The City of Sydney provides a good example of this. The Fishmans Bend Framework Plan Policy objective is to 'support the creation of a precinct of design excellence.'

5.2 Metrics Involved

The draft Framework Plan calls for some 40,000 jobs and well serviced medium and high-density housing options for up to 80,000 people. This results in an average density of 323 residents/hectare or 162 dwellings per gross hectare (including parks and roads).

In the Lorimer precinct population targets are provision of 6,000 jobs and 12,000 residents.

As tabled in my evidence the European examples have lower densities than Lorimers' 312-350 dwellings/ha

It is interesting to note the Grattan Institute's commentary that the building mix in Melbourne is wrong and more needs to be built in the middle suburbs, rich in infrastructure.

'Melbourne's population grew by 126,000 in 2016, much faster than 94,000 per year as forecast in the state Government's 2017 Plan Melbourne. Melbourne is projected to grow to 8 million people by 2050, or roughly the same size of London today. Melbourne needs a new housing game plan. It should follow Sydney's lead, reforming planning rules to encourage building in middle suburbs already well serviced by infrastructure. Sydney has added 60,000 new apartments in middle-ring suburbs in the past 4 years, mostly buildings of 4 to 9 stories. In contrast only 25000 new apartments were built in Melbourne's middle ring suburbs over the past 4 years. Melbourne is getting the mix wrong. Too much of the new housing is CBD high-rises of 20 stories or more.'

(Grattan Institute March 2018)

Precinct Area

The precinct area is 25 hectares. The existing gross developable area (excluding parks and streets) is 21.4 hectares. The proposed gross developable area is 19.7 hectares. The area covered by existing permits is 1.2 hectares leaving 18.5 hectares of net developable area. It is not quite clear if Lorimer Street is included in this area. It is clear that the area includes the roads, projected green linkages and the Park in the center of the precinct. The site area divided by the number of dwellings gives the gross developable dwelling density. For this report I have assumed 2 inhabitants per dwelling.

5.2.1 Proposed Residential Density

Current densities in Lorimer are:

- Current development permits and applications have an average dwelling density of 914 dwellings per hectare (page 7 of Adeline Pearson's Lorimer Built Form and Capacity Modelling report).
- The proposed density for Lorimer under GC81 is 255/ha based upon a 75% buildout of the precinct.
- The draft Framework suggests a FAR of 5.4 to 1 with a minimum commercial FAR of 1.7 to 1 as shown on the next page.

5.2.2 Site Metric Controls

Floor area Ratio

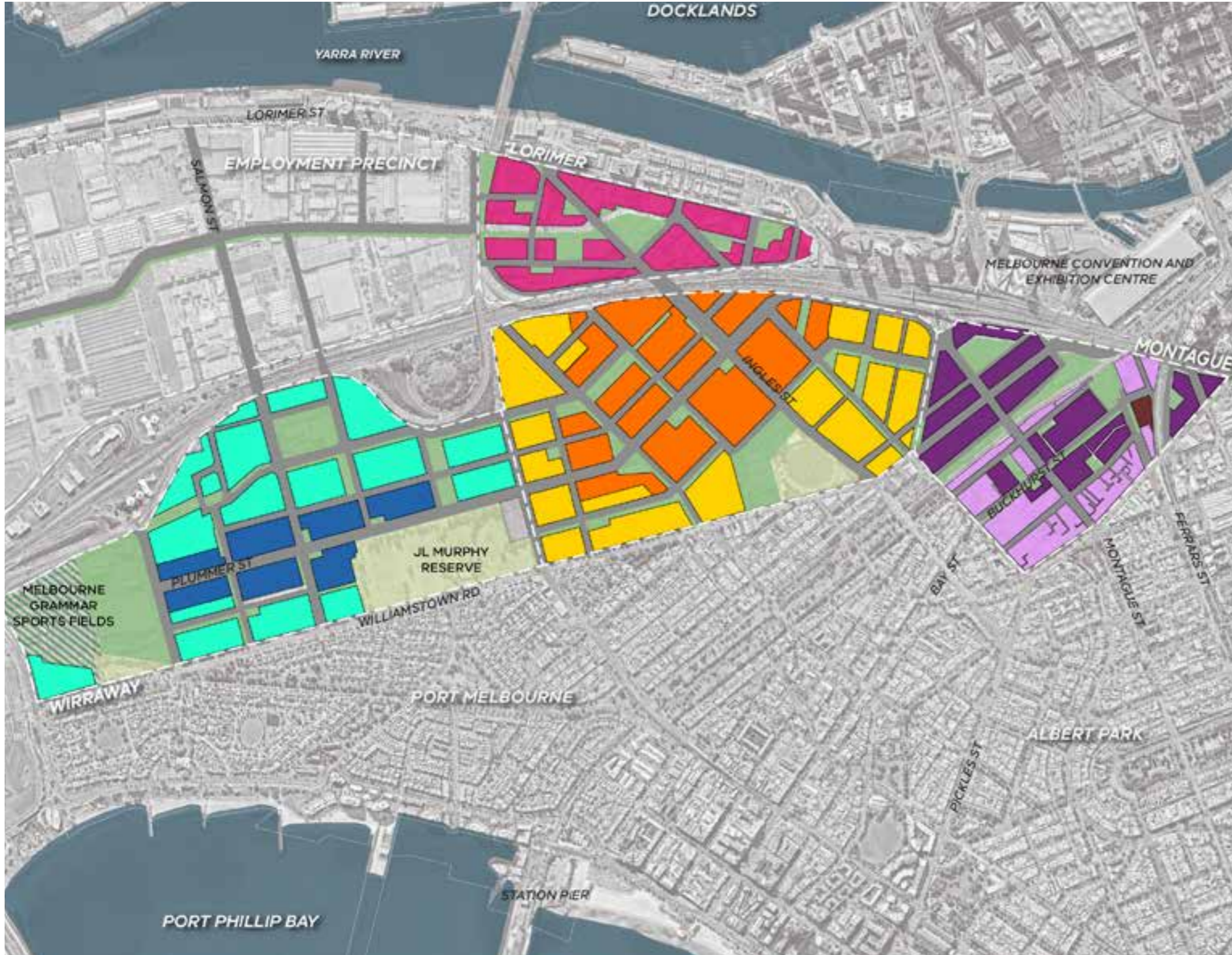

Floor area ratio (FAR) controls

Legend

Core		
Precinct	FAR	Minimum commercial FAR
Wirraway	4.1:1	1.9:1
Sandridge	8.1:1	3.7:1
Montague	6.1:1	1.6:1
Lorimer	5.4:1	1.7:1

Non-Core	
Precinct	FAR
Wirraway	2.1:1
Sandridge	3.3:1
Montague	3.0:1

- Existing open space
- Proposed open / urban space
- Private open space

The following average dwelling sizes have been used to develop these Floor Area Ratios:

- 1 bed: 50sq/m
- 2 bed: 70sq/m
- 3 bed: 110sq/m
- 4 bed 130sq/m



Figure 2

5.2.3 Site Metric Controls

Building Height Controls

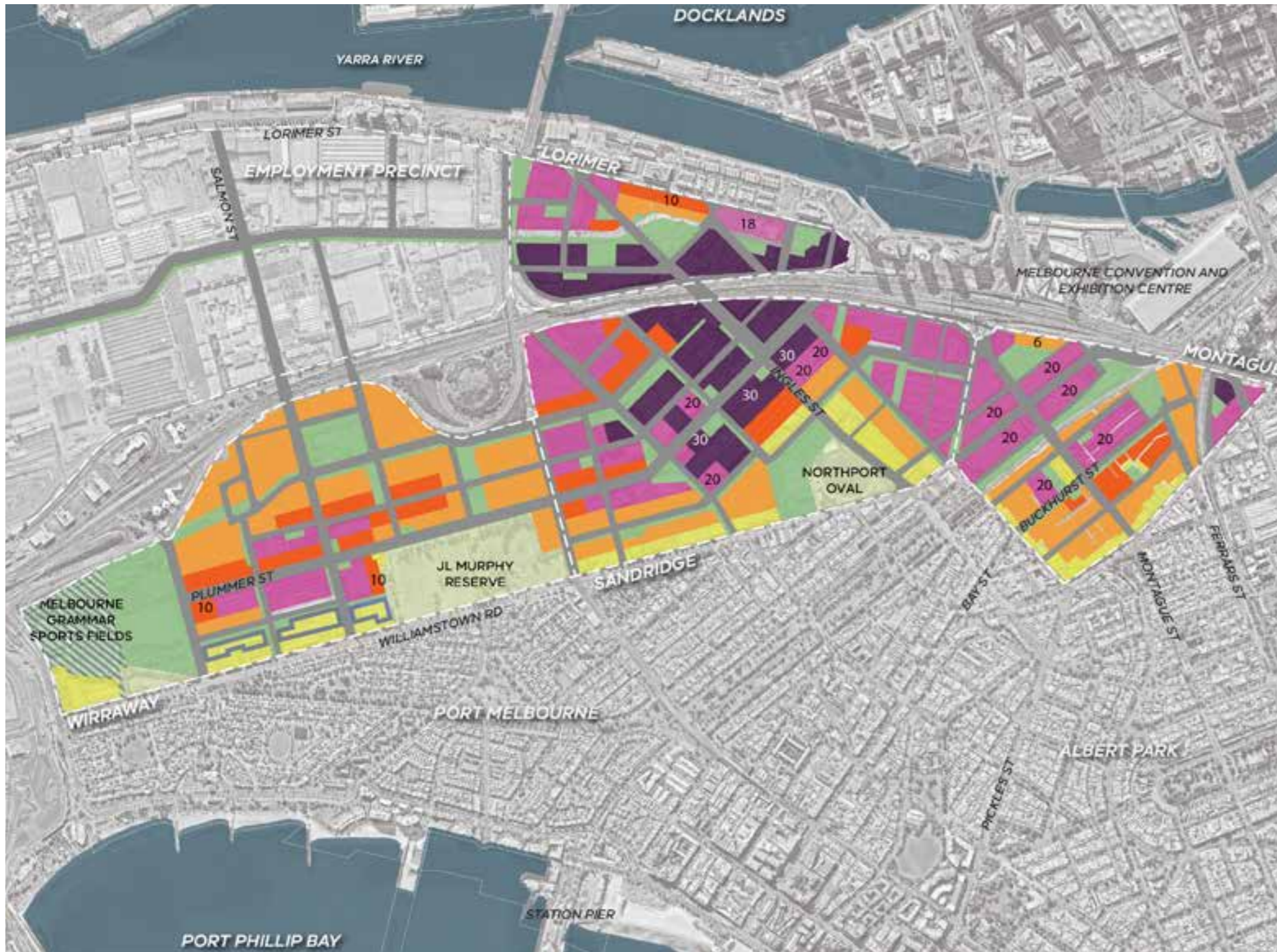

Building height controls

Legend

- Mandatory*
- 4 storeys
- Discretionary*
- 4 storeys
- 8 storeys (except 6 storeys within Wirraway)
- 12 storeys (except where noted)
- 24 storeys (except where noted)
- Unlimited (except where noted)
- Existing open space
- Proposed open / urban space
- Private open space



Figure 3

5.2.4 Different ways of Achieving Density

I have tabled as part of my evidence a series of typologies. FAR's of 3.5 to 1 to 6 to 1. These are to show that the tower on podium typology is not necessary the only high-density typology. Construction cost is a significant factor in providing diverse and affordable housing, with the tower on podium an expensive typology.

5.2.4 Different ways of Achieving Density

Metric Study

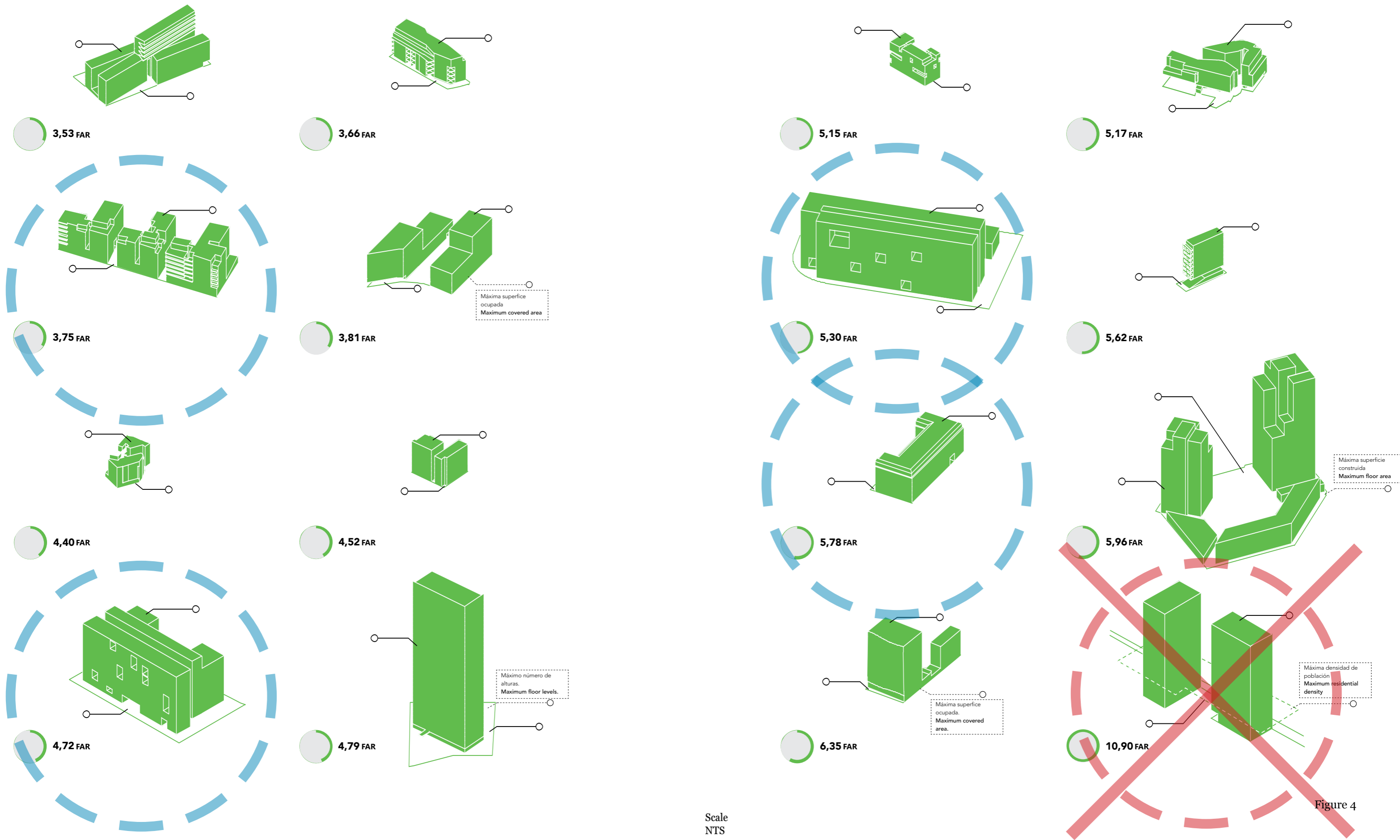

Scale
NTS

Figure 4

5.2.5 Different ways of Achieving Density

Applicable Precedents

5.2.5.1 Brenac & Gonzalez, Paris

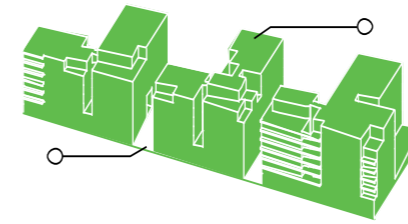

3,75 FAR

5.2.5.2 Kengo Kuma, Tokyo

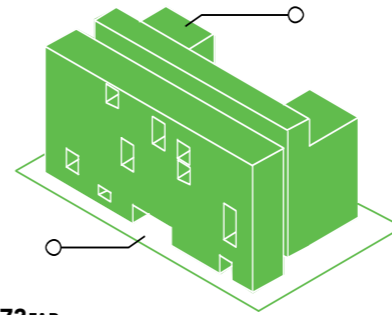

4,72 FAR

5.2.5.3 ADH/Workstation, Tokyo

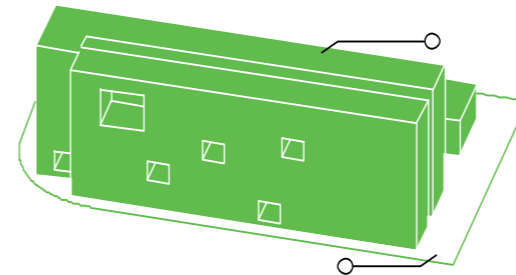

5,30 FAR

5.2.5.4 Baumschlager & Eberle, Vienna

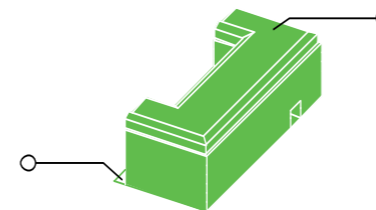

5,78 FAR

5.2.5.1 Brenac & Gonzalez, Paris

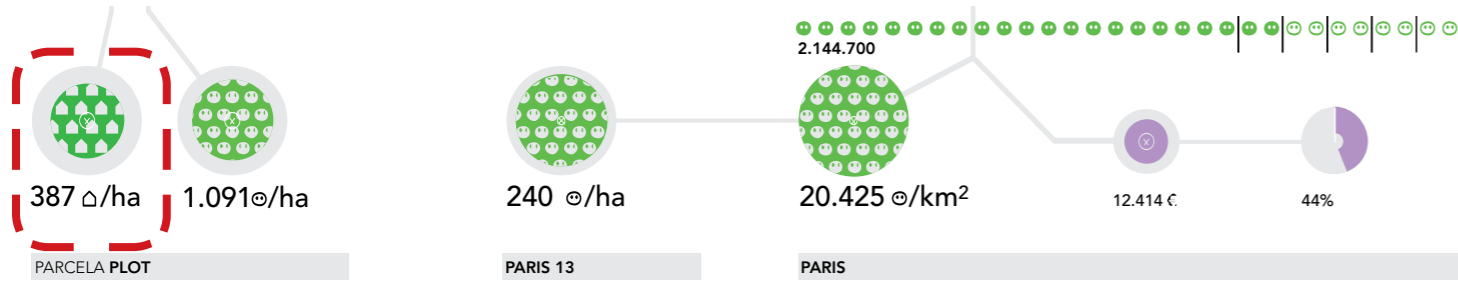

DENSIDADES DENSITY DATA

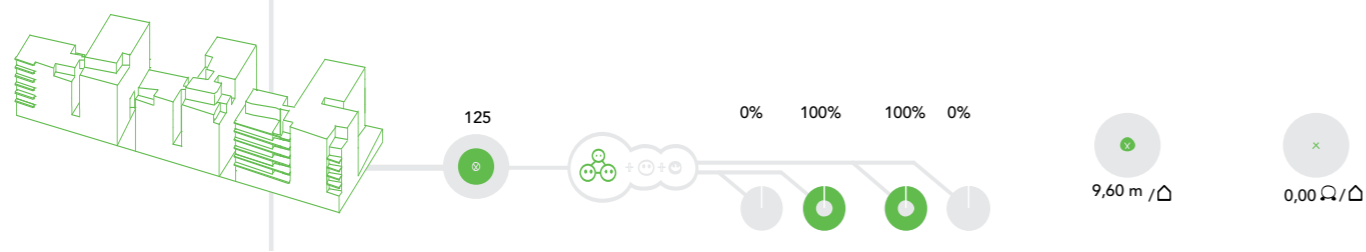
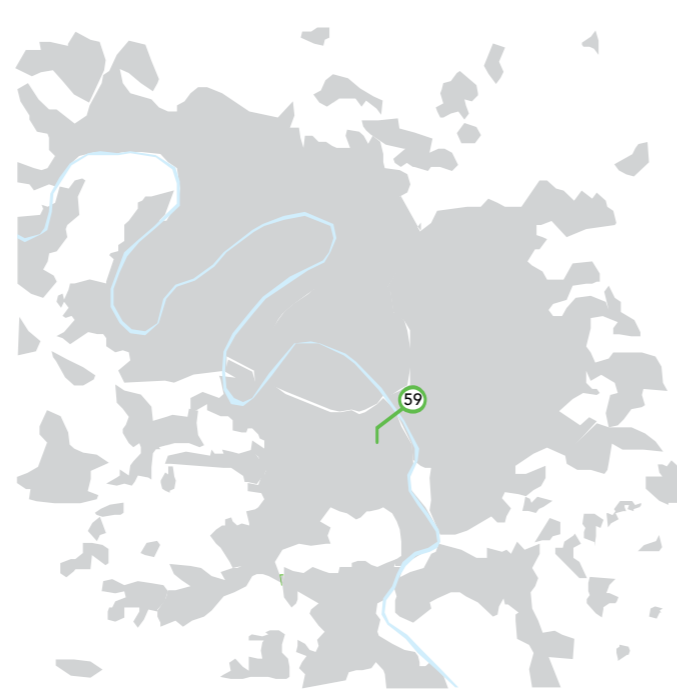

Summary -

- The development includes a multipurpose tender that comprises of a variety of mixed use spaces – such as integrated homes, offices and facilities including public rental homes.
- The integration of public rental homes in this downtown location was intended to curb the tendency to force the majority of the population to look for homes in the outer suburbs.
- The 'L' shaped plan of the building permits for light to enter the garden area and units. While the 3 porches 'bring the group of patios together, creating both unity and diversity in each exterior space'.
- The building was also designed to limit the number of lift shafts and consequently allow for extra space to be allocated to housing units.

(Fernández Per, Mozas and Arpa, 2007)



Figure 5

5.2.5.2 Kengo Kuma, Tokyo



Summary -

- ‘Allows a possibility to build an average floor area of 3.5 to result in a very high residential and population density’.
- A modern interpretation of Le Corbusier’s work, a type of housing that surpasses traditional conventions and integrates them into a vertical city with spaces for work, business and collective families.
- The development includes child care, offices and other services to support urban living.
- ‘Communication Atrium’s’ are located in the centres of the forms and surrounded by Annex units 60m² and Annex units 25m².
- Annex units uses: bedroom, study, SOHO or store.
- Through creating these different sized spaces and uses the 3D street is formed.

(Fernández Per, Mozas and Arpa, 2007)



(Fernández Per, Mozas and Arpa, 2007)
Figure 6

5.2.5.3 ADH/Workstation, Tokyo

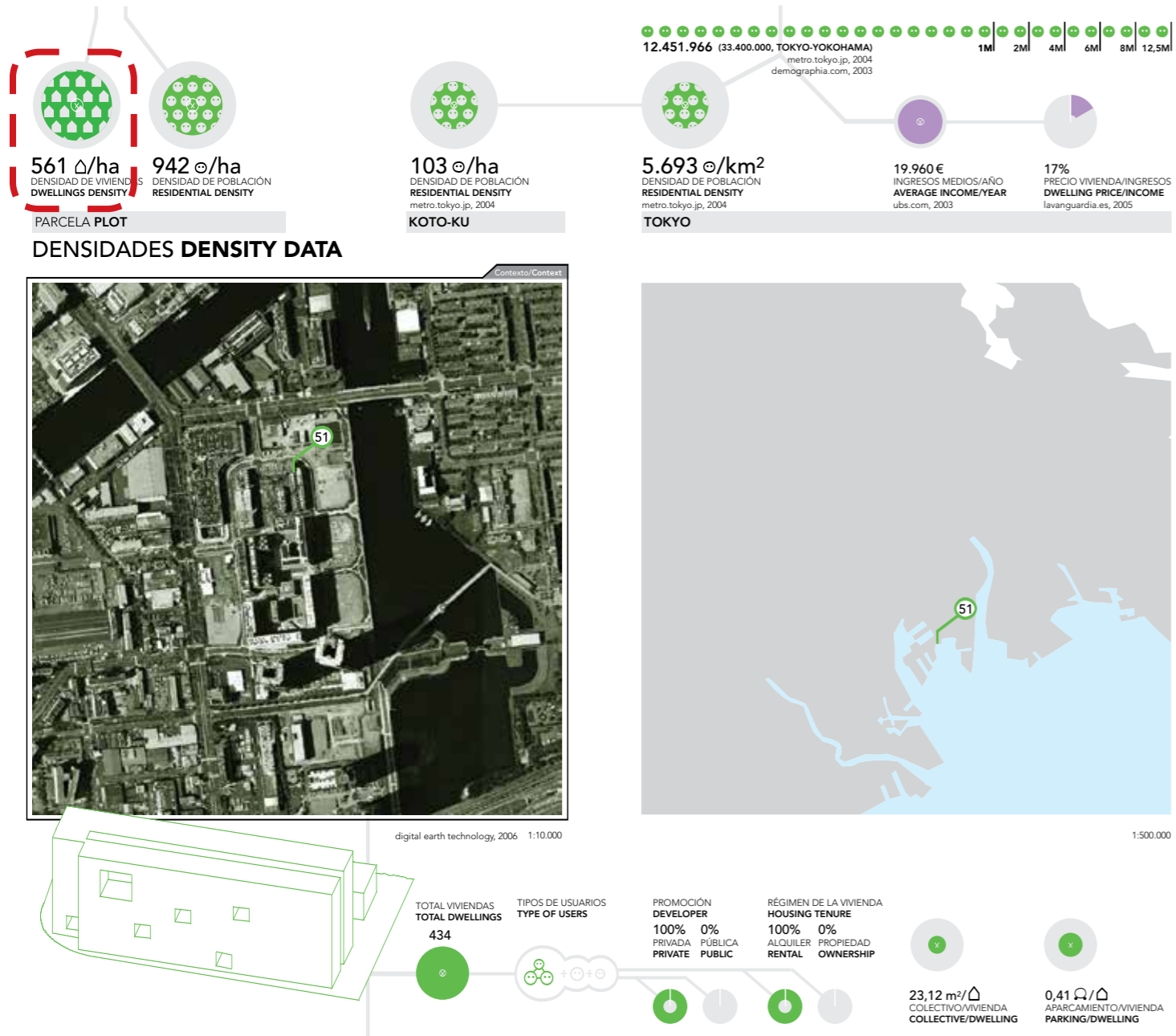

Summary -

- The multipurpose master plan combines live/work arrangements in a high density city.
- Toyo Ito's master plan model shows a dense city, with alternate uses and adapted to new life styles.
- The master plan is divided by a centralized 'S' shaped avenue in which all shopping and community facilities reside, creating a centralised key generator for the public.
- The master plan is subdivided into 6 blocks. Although the buildings do represent a high FAR the use of light wells and air pockets to help open the spaces and aid in providing natural ventilation and natural light.

(Fernández Per, Mozas and Arpa, 2007)

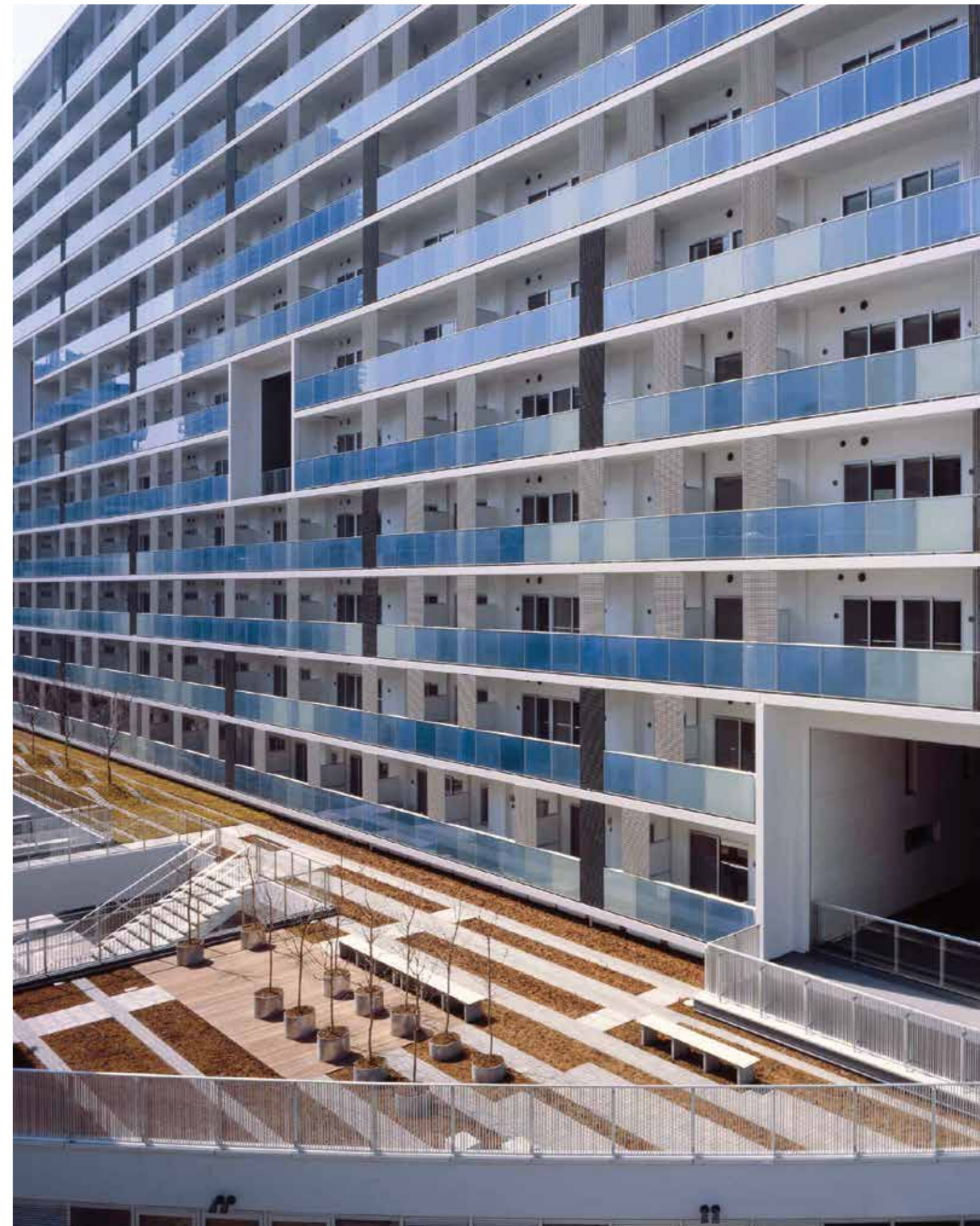

(Fernández Per, Mozas and Arpa, 2007)
Figure 7

5.2.5.4 Baumschlager & Eberle, Vienna

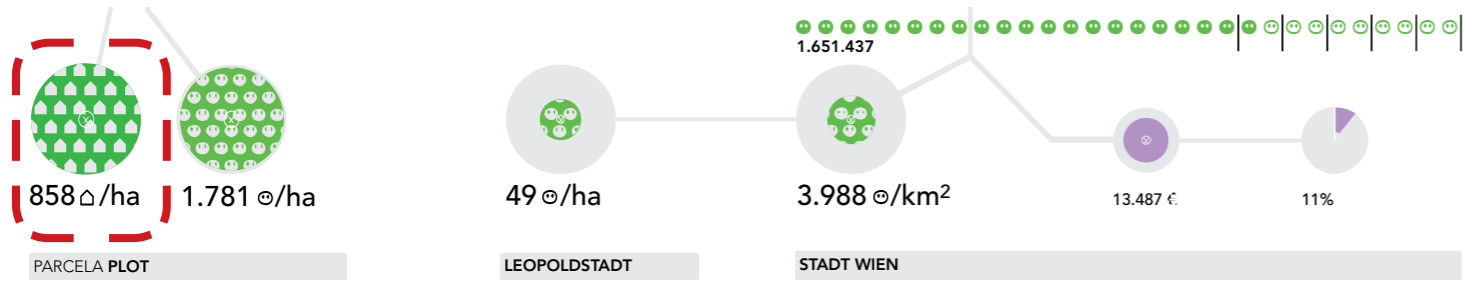

DENSIDADES DENSITY DATA

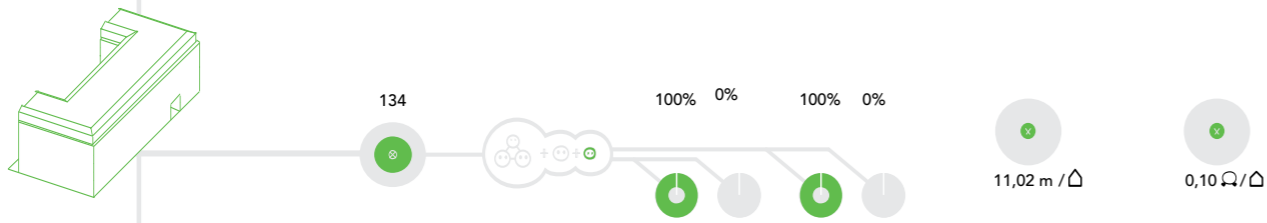
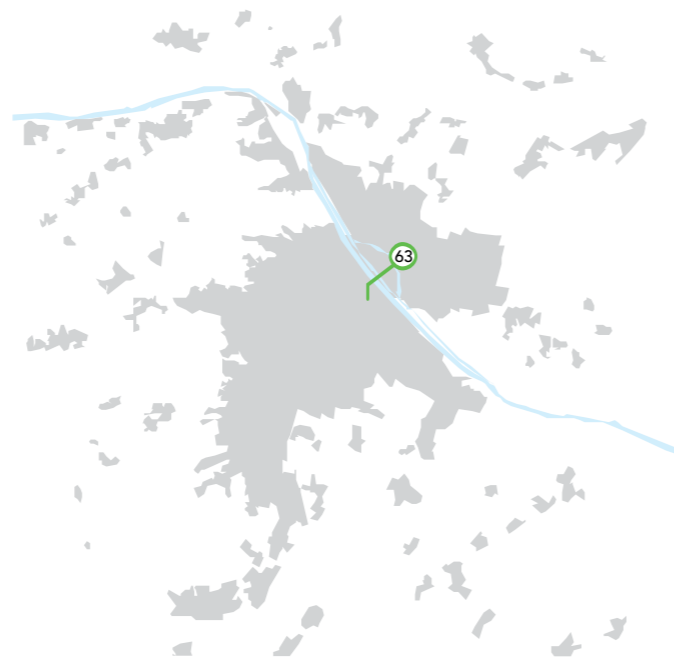

PARCELA PLOT

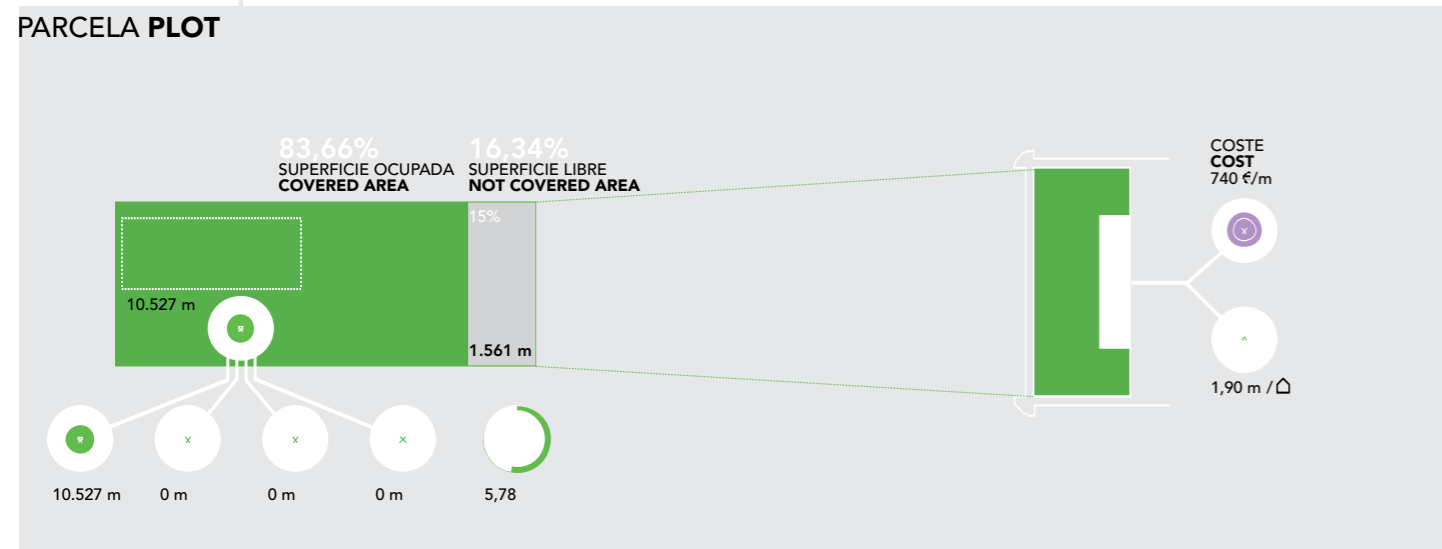
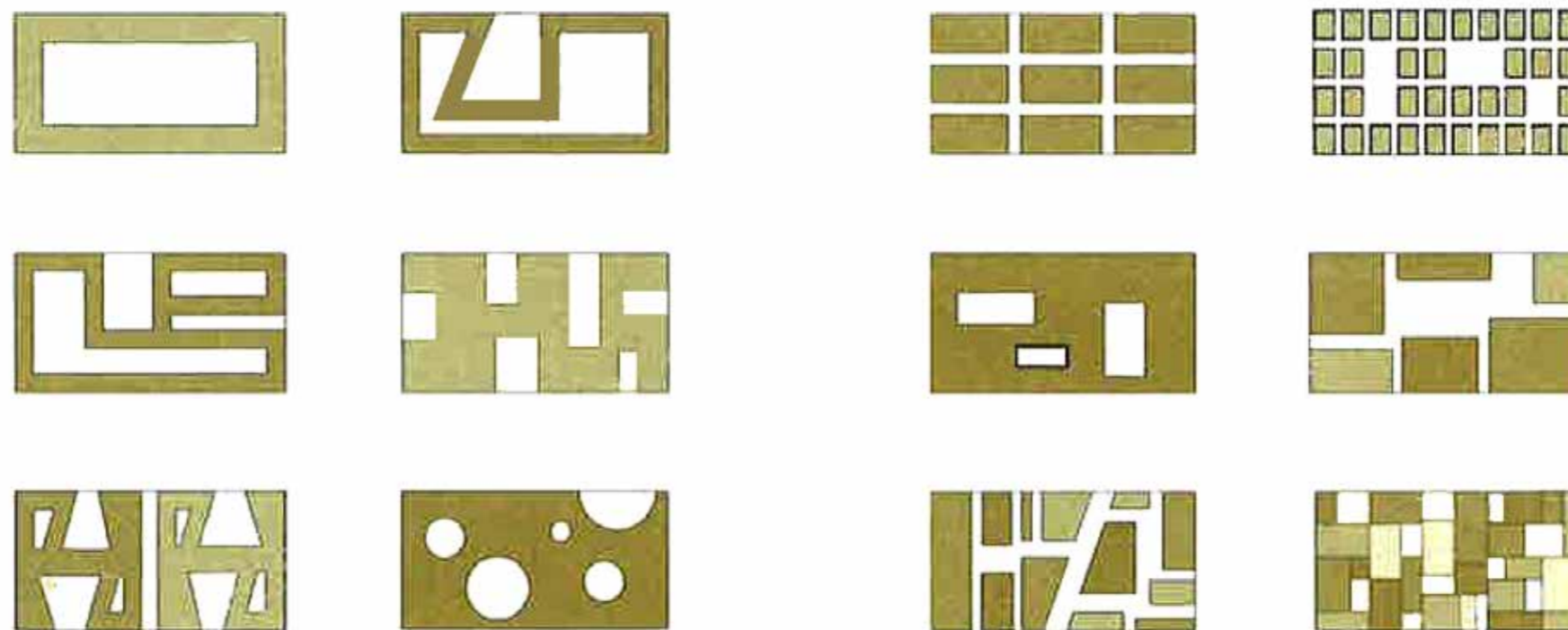
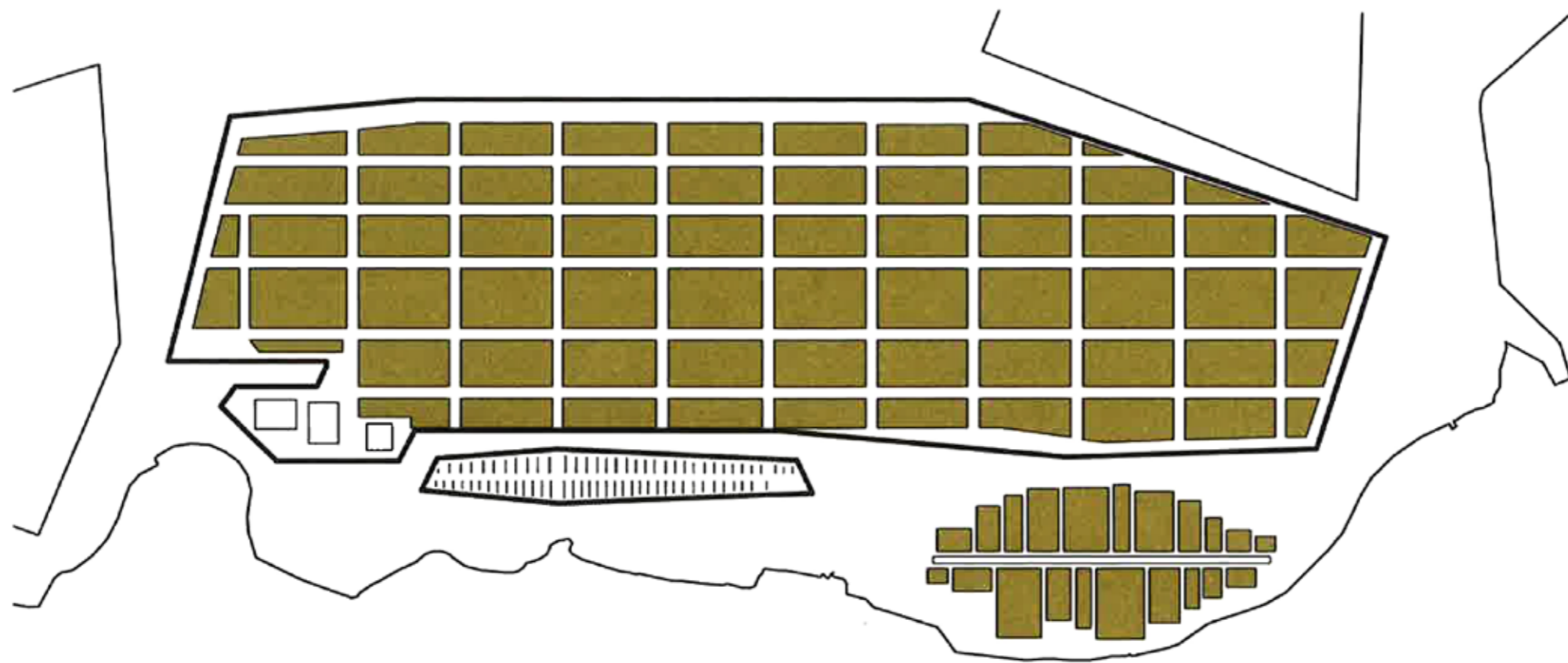

Figure 8

63 | 1.781 | BAUMSCHLAGER & EBERLE | VIENNA | AT | 05



These plans show master planning strategies in achieving FAR's within the guidelines of Fisherman's Bend - while creating inviting public/private open space, consequently aiding in developing a sense of community.

(Claus, Dongen and Schaap, 2001)
Figure 9

5.3 Public Transport

The Fisherman's Bend vision (DELWP) 2016 states that Fisherman's Bend is to be 'A thriving place that is a leading example for environmental sustainability, livability, connectivity, diversity and innovation.' Globally, urban renewal is usually started by transport connections. Certainly, the late delivery of public transport is a strategic issue. The new tram route proposed for Lorimer is essential and should be completed with haste. The proposed metro stations can certainly assist in achieving higher densities throughout Fishermans Bend.

In literature on public transport it is noted that there is a positive relationship between job density and public transport. In areas with good public and active transport access, there is larger access to a wider labour market. Docklands exhibits that when job density increases the use of private transport (cars to work) decreases as a result of better public transport infrastructure. This shows the importance of having a relationship between good public transport and high job density.

<https://chartingtransport.com/tag/density>

In summary to achieve a true mixed-use community, public transport is critical and needs to be delivered early.

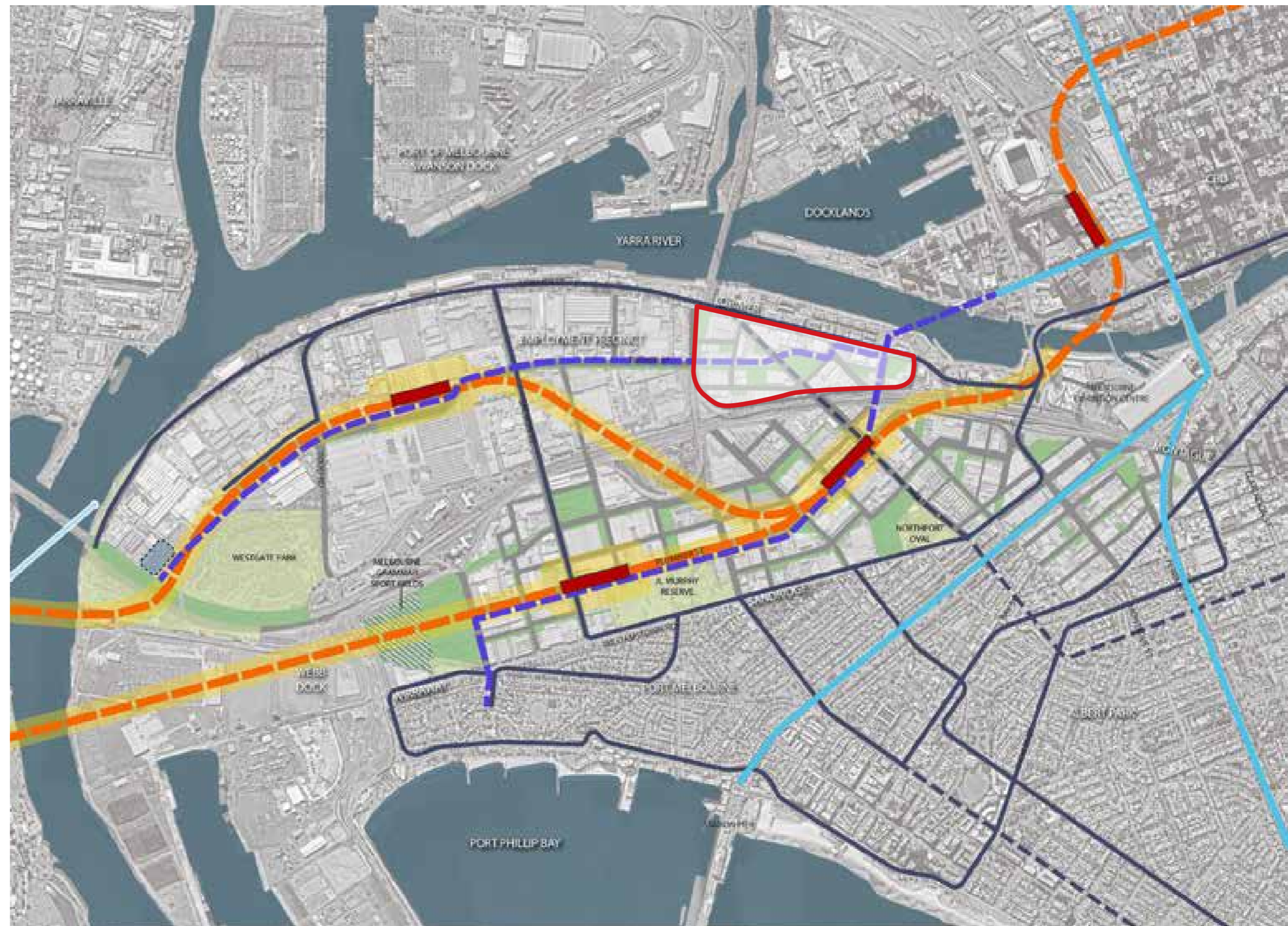

Public transport

Legend	
	Potential metro station
	Potential metro alignment
	Metro rail investigation area
	Existing tram route
	Proposed tram route
	Proposed bus route
	Existing punt connection
	Potential tram depot
	Existing open space
	Proposed open / urban space
	Private open space

Sustainability goals 31

Figure 10

5.4 Parking

The existing and proposed controls will create a large number of car parks at Fishermans Bend.

Carparking presents huge issues in staged projects such as Fishermans Bend. Car parking drives the unfortunate typology of the tower on podium. The densities suggested are creating large podiums that are up to 6 storeys high. It is acknowledged that most podiums are sleeved towards the street. It is also noted in clause 49.09.07 that 'car parking areas not within a basement should have level floors and a floor-to-floor height no less than 3.8 metres and should make provision for future conversion of car parking uses over time.'

The provision of parking in the absence of public transport will create carparking podiums with towers above. To suggest that carparking be future proofed at 3.8 metres floor to floor is an untested approach. Car parks don't easily convert to office/commercial uses. A control limiting carparking to a maximum of .5 cars/apartment is an appropriate control. Additional parking could be provided remotely prior to additional public transport being provided. Another approach could be to allow developers a bonus for using mechanical carparking systems that reduce the size and scale of podiums.

5.5 Urban Design

The proposed controls with the FAR and FAU are resultant of capacity modelling. Whilst FAR's are a commonly used control elsewhere FAR's don't necessarily provide assistance in what streets and buildings look and feel like. Missing in the proposed framework is a visual analysis of what Fishermans Bend could become. This analysis could highlight important streets and boulevards and significant landmark sites. There appears to be little correlation between the controls in the DDO and the urban design vision.

The controls are aligning land use to public transport use. The resultant planning applications approved and in the system are almost all a tower on podium typology. This is in reality a Southbank solution moved to Fisherman's Bend. From a place making strategy and creating the City of the future model this architectural typology is the worst model. The suggested Design and Development overlay (schedule 67) includes a series of maps that represent the built form controls.

These do suggest a lower street wall of some 4 to 6 levels. Adjacent to this, street wall are heights that range to above 24 stories. What is apparent in the modelling done by both The City of Melbourne and Leanne Hodyl's DELWP analysis is that a tower on podium is the typology modeled.

I generally concur with Leanne Hodyl's separations of buildings up to 30 metres. Above 30 metres I would prefer the NSW ADG (Apartment Design Guide) control of 24 metres between habitable rooms. I disagree with the 12-metre setback criteria for habitable to habitable rooms across a laneway. To encourage activation and diverse typologies this should be reduced to 6 metres.

I have tabled in my evidence a number of European and Japanese examples of built form that are an urban block models that still achieve high densities. The urban block achieves a much better street interface.

While not disagreeing with the Fisherman's Bend Draft Framework that notes that there need to be 'neighbourhoods that have a distinct feel and range of housing outcomes', it is very unfortunate that the Lorimer Precinct isn't more strongly connected with the Yarra River. It is surprising that a greater emphasis of connectivity through Yarra's Edge to the Yarra has not been provided. Visual and physical connections could certainly decant some of the Yarra Rivers amenity into Lorimer Precinct (see figure 12). It is surprising that in all the planning maps and overlays Yarra's Edge is shown as an amorphous mass. While acknowledging that Lorimer Street is an important transport route to the Port, it is still relevant to analyse the development north of Lorimer street and to 'knit' it back into the Lorimer Precinct.

Another observation is the scale and detail of important planning maps, that are currently very small and almost illegible [figure 10 of clause 21.13.2] (see figure 11).

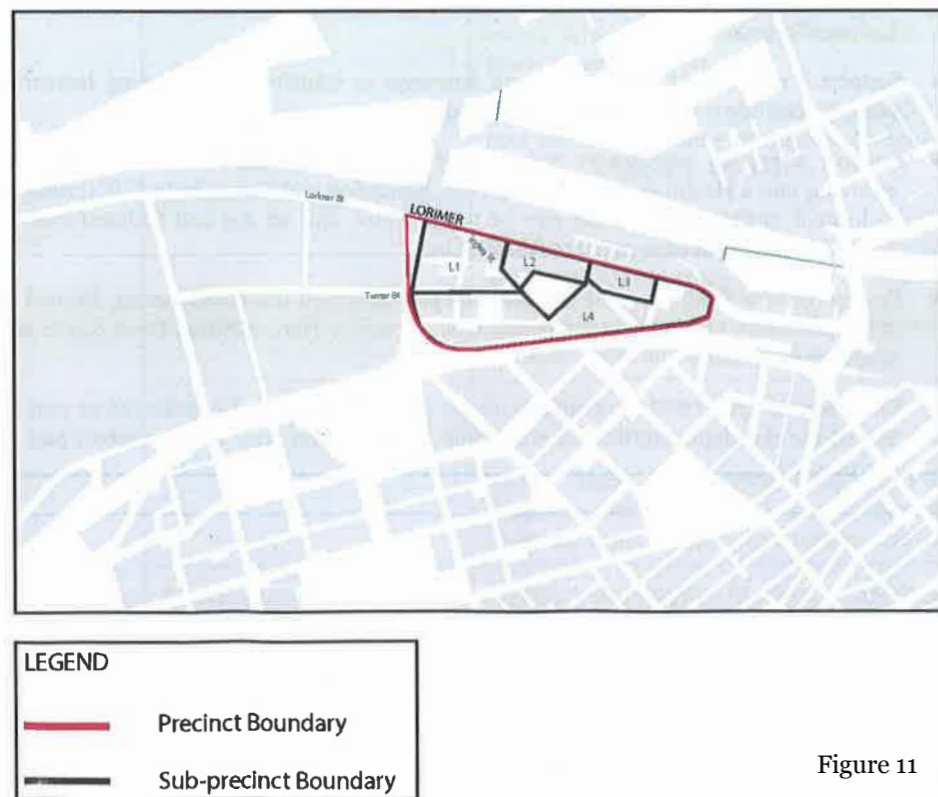

Figure 11

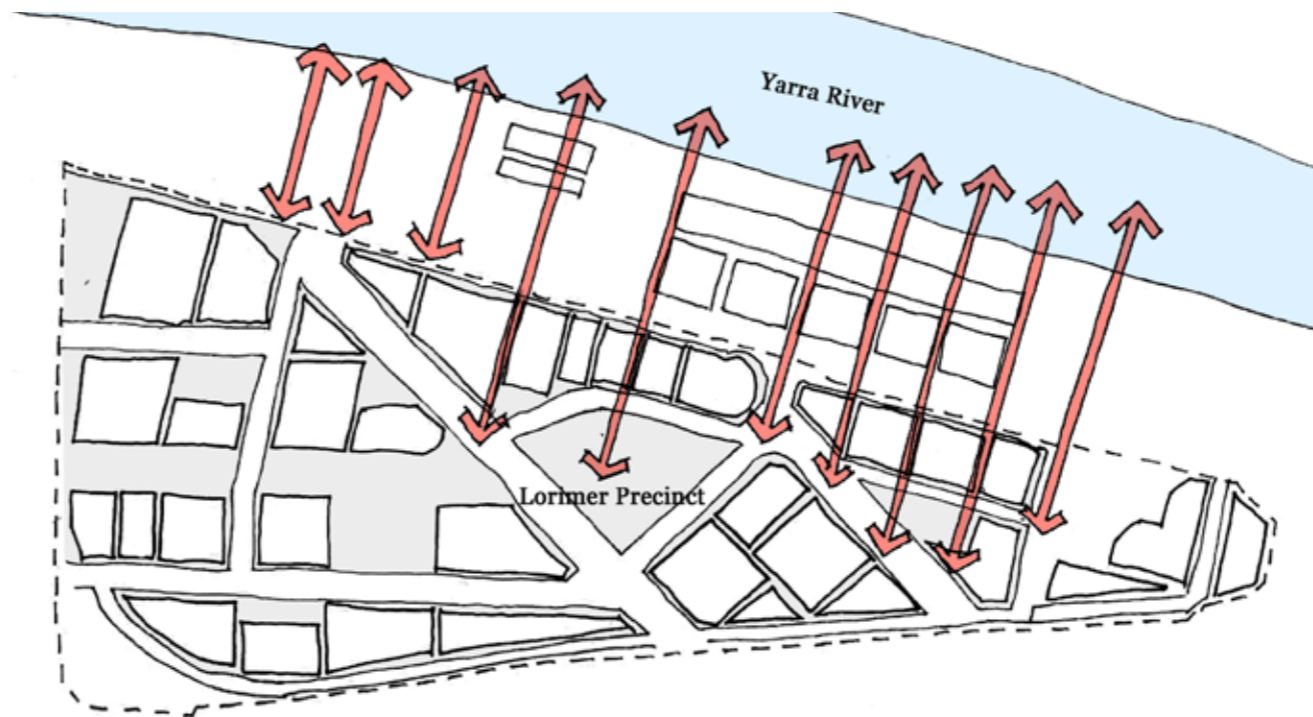

Figure 12

5.6 Other Examples

5.6.1 Ashmore Precinct - Sydney, Australia



Figure 13

5.6.2 Docklands - Amsterdam, Netherlands



Figure 14

5.6.3 Mirador Apartments - Madrid, Spain



Figure 15

5.6.1 Ashmore Precinct - Sydney, Australia

Key features are:

Land uses including residential, commercial and the potential for a retail precinct building design and form with a focus on achieving design excellence and retaining the character of the area by providing a transition in the height, scale and type of building.

Staging to ensure that all individually owned development sites, within the overall Precinct, can develop independently without adverse impacts on neighboring areas. Similarly, to Fishermans Bend a public realm, including a new parks and new streets.

Effective pedestrian, cycle and traffic linkages; and critical infrastructure elements to manage storm water.

Extensive urban design analysis was undertaken to develop appropriate controls for building heights, built form and density of development. Individual lots can be redeveloped independently and will be designed so as not to overshadow adjacent properties or block city views from Sydney Park. The DCP also aims to provide a range of housing types such as terraces, apartments and live-work accommodation.

Unfortunately in the Fishermans Bend Framework Plan there is little urban design analysis of the forms created, the architecture and the urban realm.



Figure 16

5.6.1 Ashmore Precinct - Sydney, Australia



City of Sydney DCP, Section 5, Specific Areas
DCP Ashmore Page 130

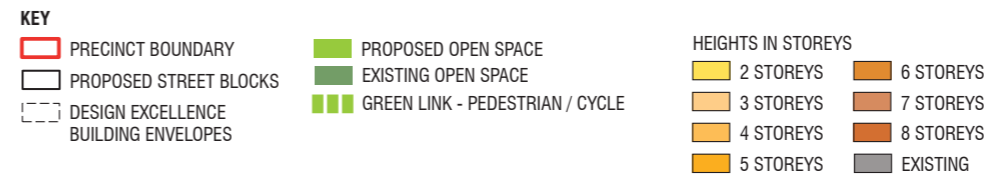
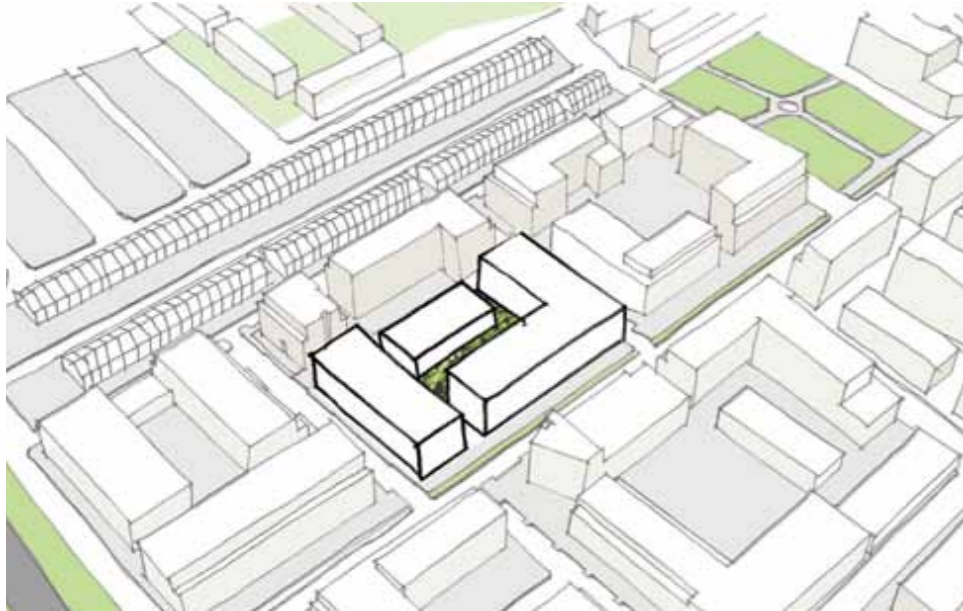

Figure 17

approved envelope study



option 1 - stage 1 da envelope

Whilst the initial analysis indicated a complying development may be possible on the stage 1 DA envelope it also indicated that achieving the bonus FSR with the preferred client plan typology was impossible, additional frontage was needed in the development envelope. In response to these constraints we developed options 2,3 and 4.

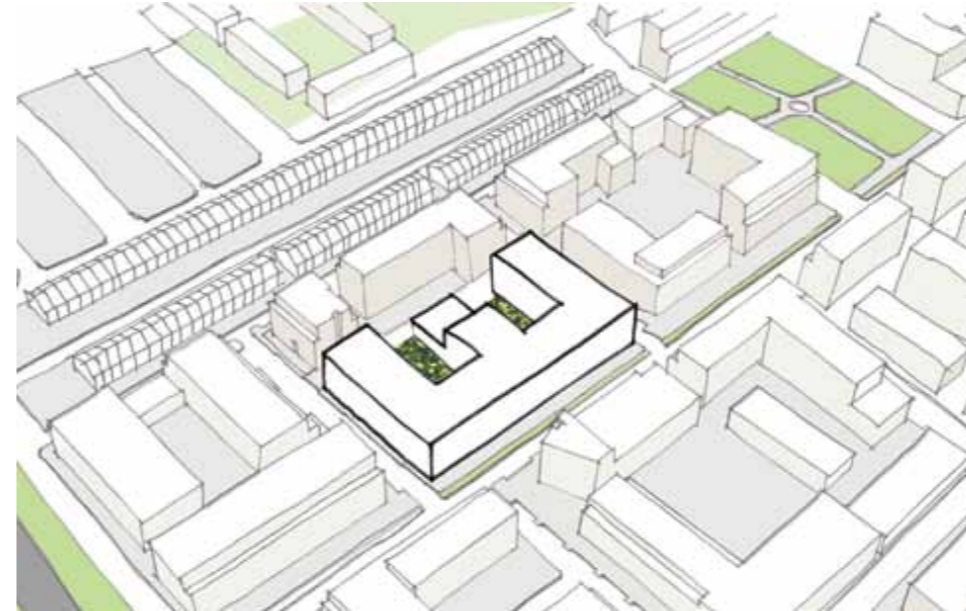

option 2 - e block

Forming the building into three north-south fingers achieved the additional frontage whilst respecting the desire to have 3 levels from on the pedestrian spine. However it resulted in the Macdonald St building becoming unacceptably long and the lack of active frontage on the northern pedestrian spine. The plan form also revealed 3 knuckles that became problematic to plan out.

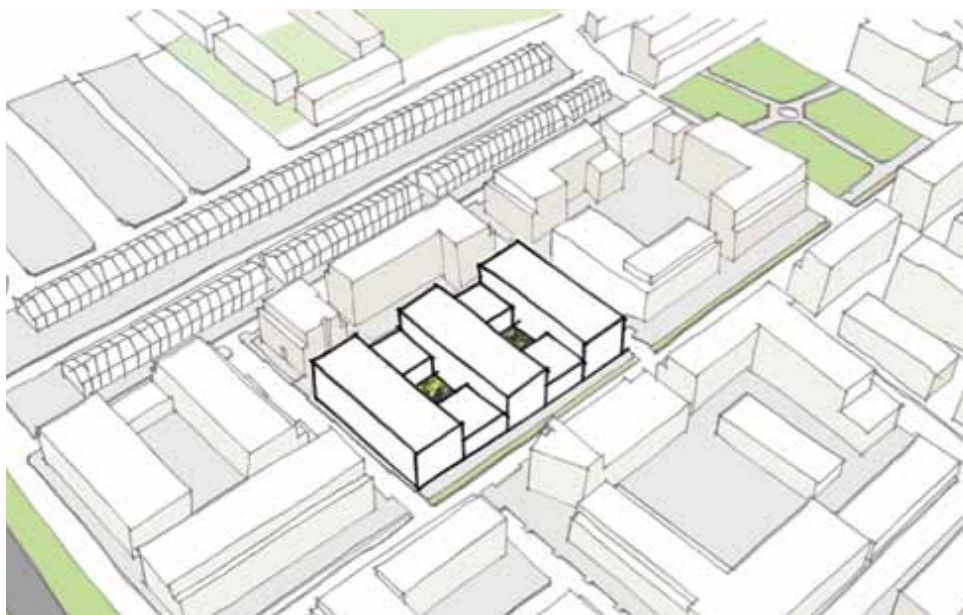

option 3 - hybrid

The hybrid eblock form was generated by pushing the east-west building to full height and creating two central courtyards similar to erko building adjacent. Solar studies revealed the sites north-south depth was insufficient to achieve the desired outcome. The buildings form was in contradiction to councils desire to have a street wall on Macdonald St and low height building to the north.

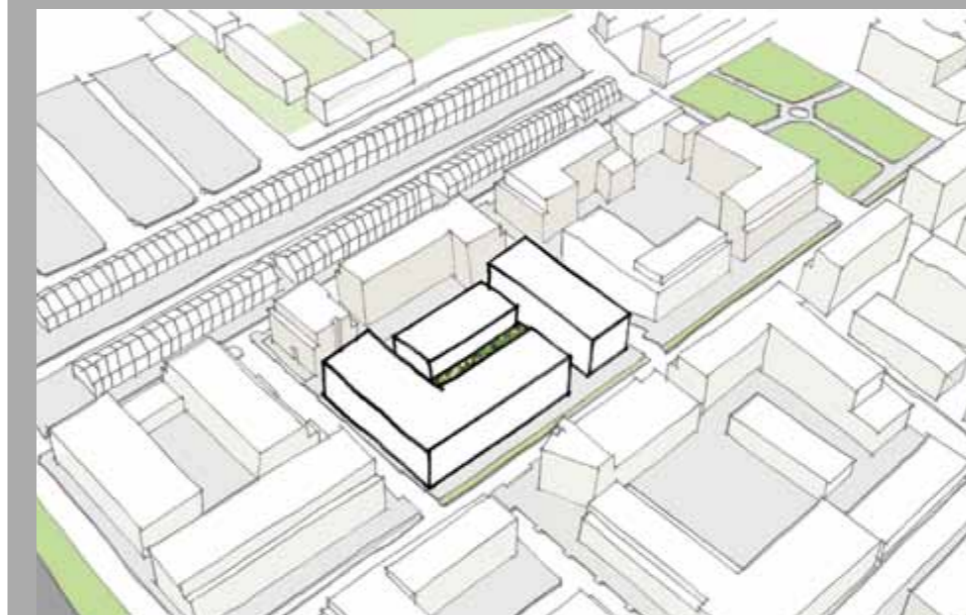

preferred option 4 - perimeter block

Forming the building into two L shaped forms, broken once on north and again to the south, created the active frontage needed to the north and reduced the building length on the south. Creating one central courtyard running east-west enhances the solar access and maximises the building frontage to the northern aspect. The result is a plan type with only 2 knuckles one of which is only over 3 levels. The separation between buildings across the courtyard is approximately 16.5m (12 to balconies) and 9 meters between buildings.

the articulated facade

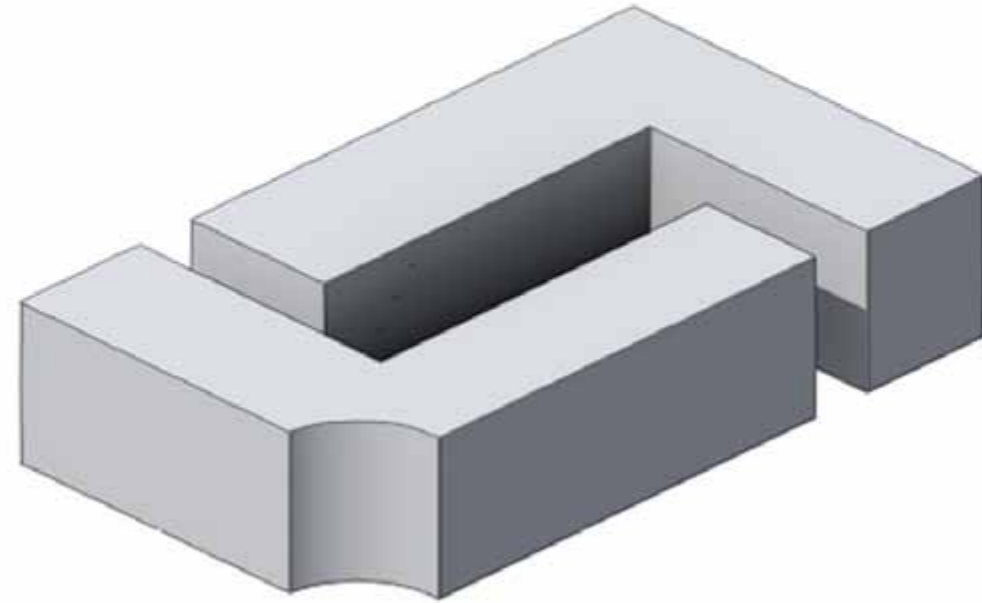

1 Resultant form derived from plan studies.

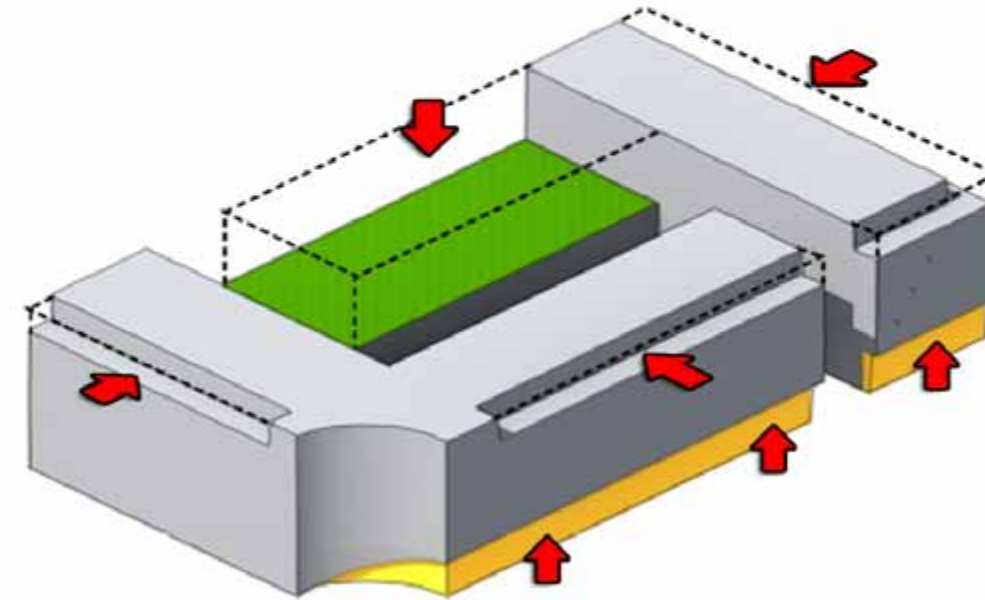

2 Setback top floor, introduce stoops and human scale to street edges.

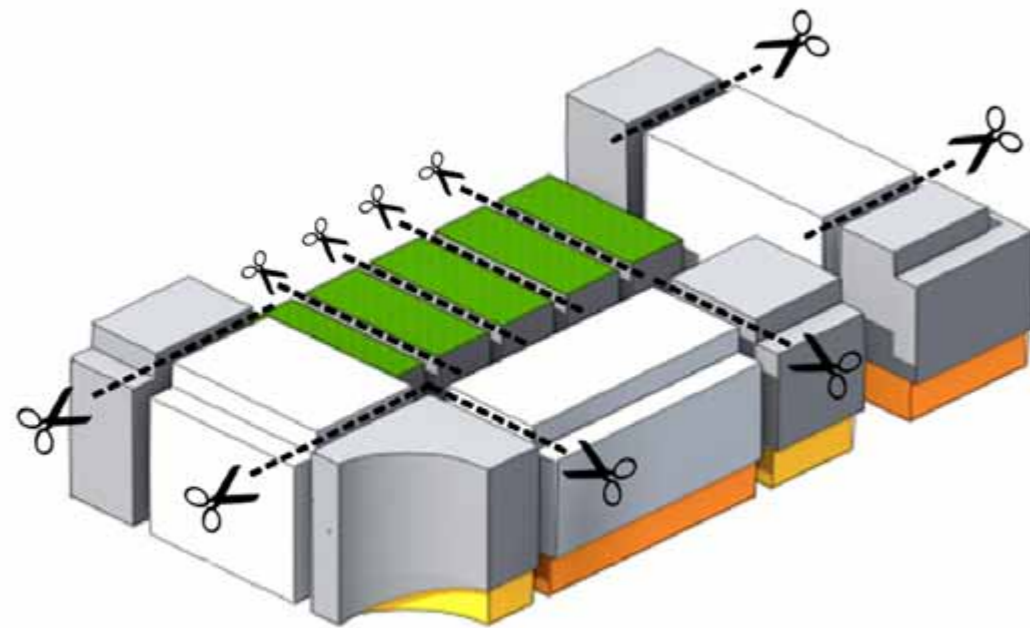

3 Slots to provide breaks in built form, reduces scale and allows light and air deep into the building.

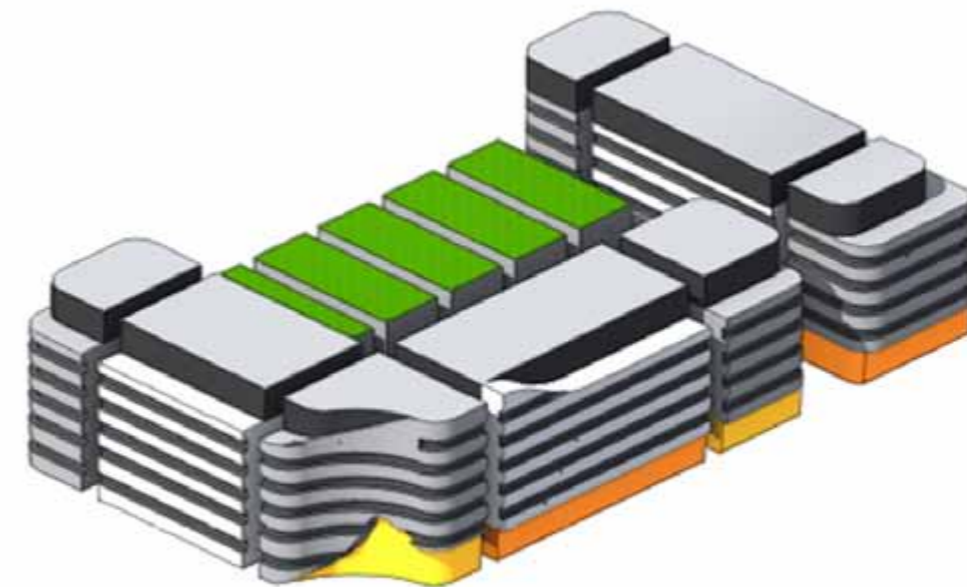

4 Celebrate corner and introduce subtle local reference, parapets and tunnels.

5.6.1 Ashmore Precinct - Sydney, Australia

Architecture
Taking a thoroughfare
approach.

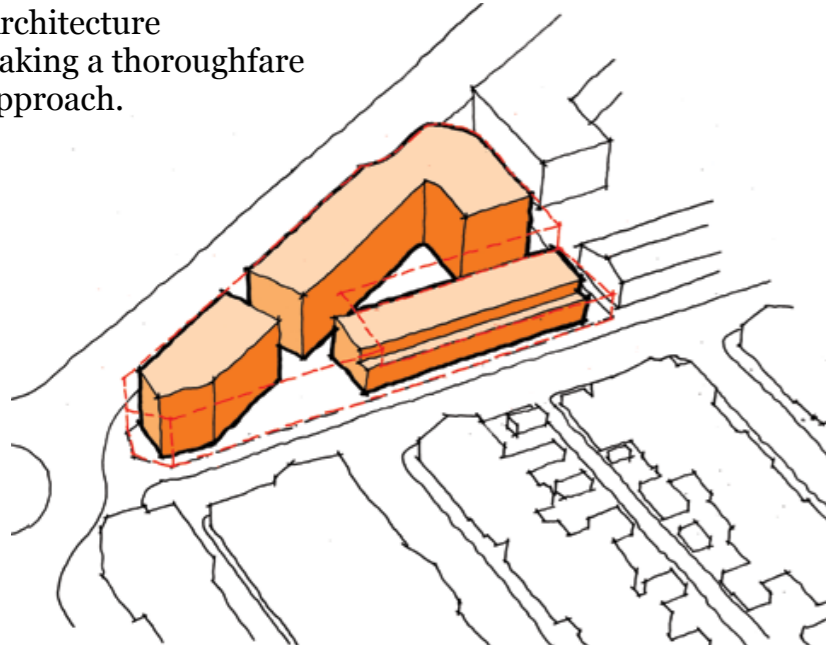

Analysis - DCP

- Internalised courtyard with significant overlooking and overshadowing issues.
- The mapping of pedestrian routes questioned the location of the thought site link with majority of the foot traffic heading to the pedestrian crossing at Mitchell Road.
- The through site link also created a view across Sydney Park road to the substation building on the opposite side of the road.



Response

- Change the location and scale of through site link enabling the northern Huntley street building to be lowered reducing overshadowing and increasing solar access.

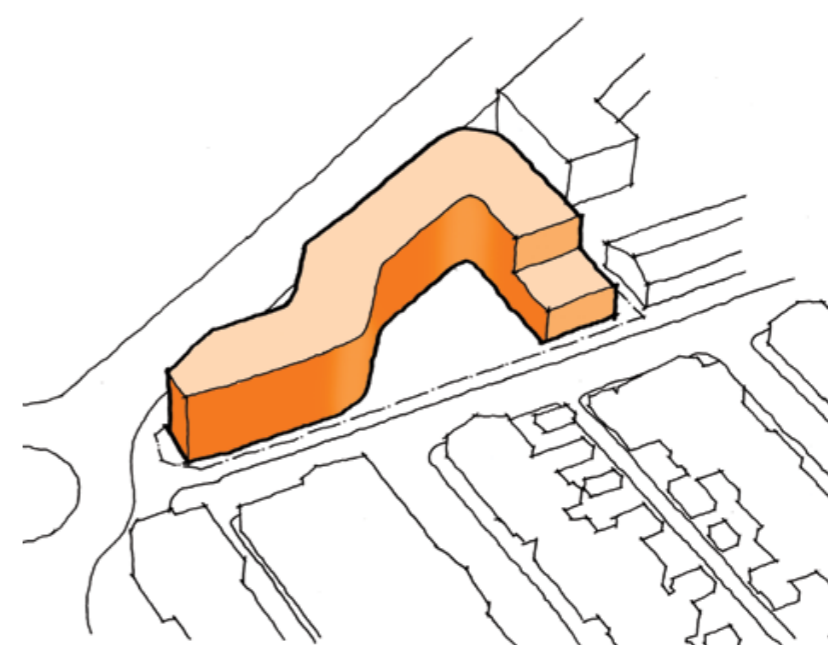

Response

- As a result of further testing and detailed floor planning the team was able to remove the northern mass completely.
- Trees along Huntley Street are kept.

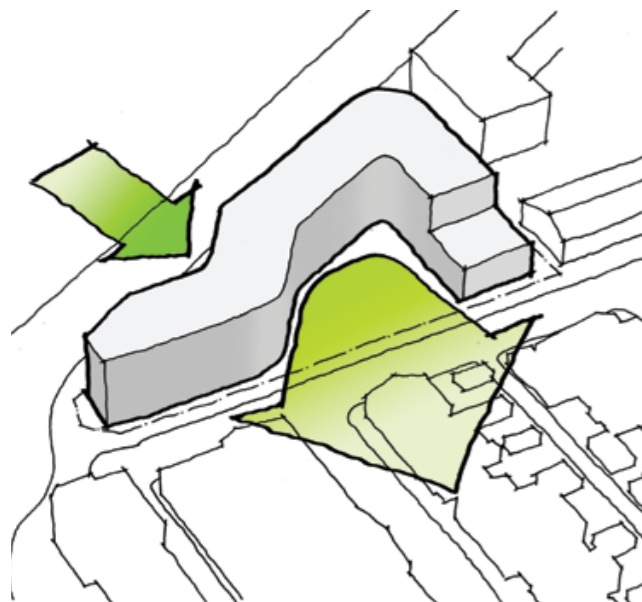

Response

- Introduce major community open space to the north to replace builtform.
- Kink building off Sydney Park Road to reduce perceived length.

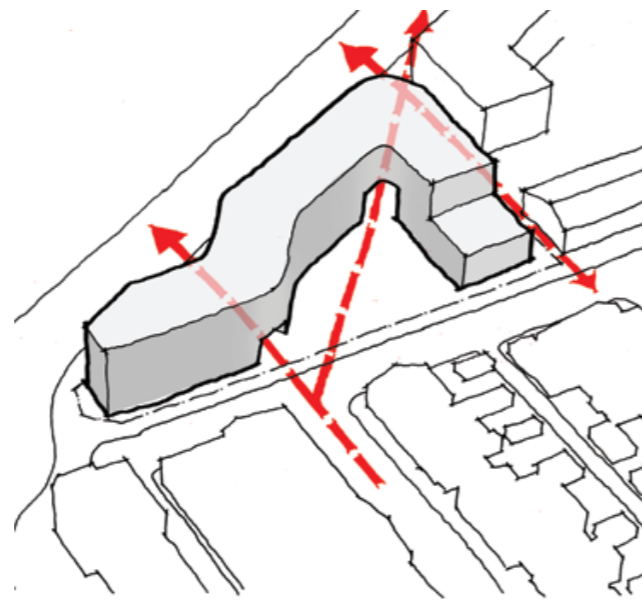

Response

- Permeate the ground plane.
- Links to match desire routes through the site.

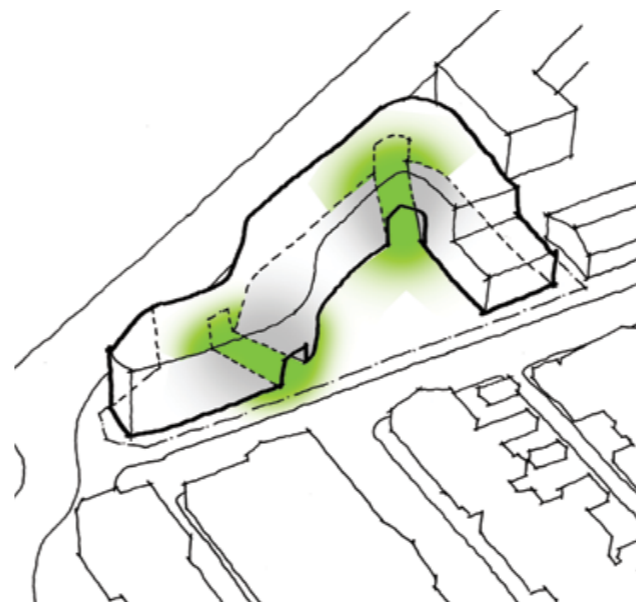

Response

- Create legible green public corridors through the building.
- Green wraps up into and over the building.

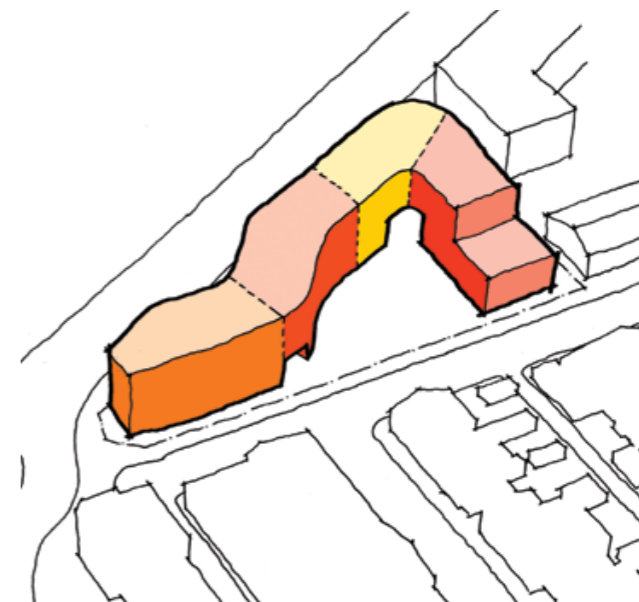

Response

- Break the larger building at these public corridors into smaller communities.
- Smaller communities are better communities.

5.6.2 Amsterdam Docklands

Historical Background

'In the 1970s, the docklands were abandoned by the shipping companies and the decay of the Eastern Docklands started.' The Eastern Docklands were then taken over by artists, squatters and city nomads, living in old buses, caravans, tents, huts and dens after aeroplanes replaced ships and the previous use of the site became redundant (Amsterdaming, 2011).

Planning goals in the 1980's – West 8 Landscape Architects devised an extraordinary high density low rise scheme of 100 dwellings per hectare for 18,000 people. Along 2 long peninsulas the plan was to develop 2500 low rise three storey dwellings in narrow blocks (West8, 2002).

Social Housing

A stand-out feature here is that firm's own housing block, winding its way across the water. Occupying the former cattle market and slaughterhouse site is a mixed-use business zone and an estate of some 600 social housing units (Architectureguide, 1996)



Figure 21

5.6.2 Amsterdam Docklands

Piraeus 1989 - 1994
 Hans Kohloff and Christian Rapp
 Amsterdam Docklands - KNSM Eiland

USE BREAKDOWN

- 'Piraeus' is a mixed-use housing block on KNSM Eiland in the former docklands of Amsterdam.
- Piraeus' comprises 304 apartments, eighteen shops and an underground parking garage. A major sculpture is incorporated into the southern courtyard.

ORIENTATION

- 'Piraeus' is built to the boundary and there are no street or side setbacks. Courtyards are not accessible from the street.

(McInerney, 2014)

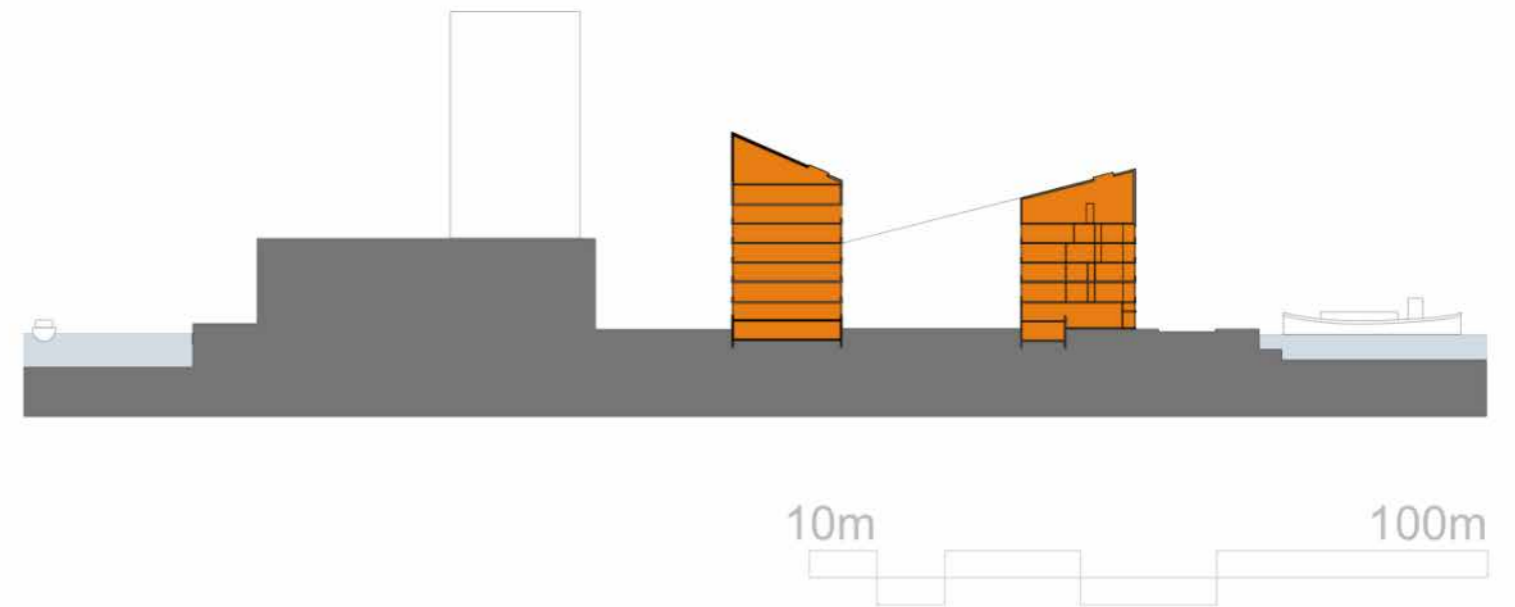
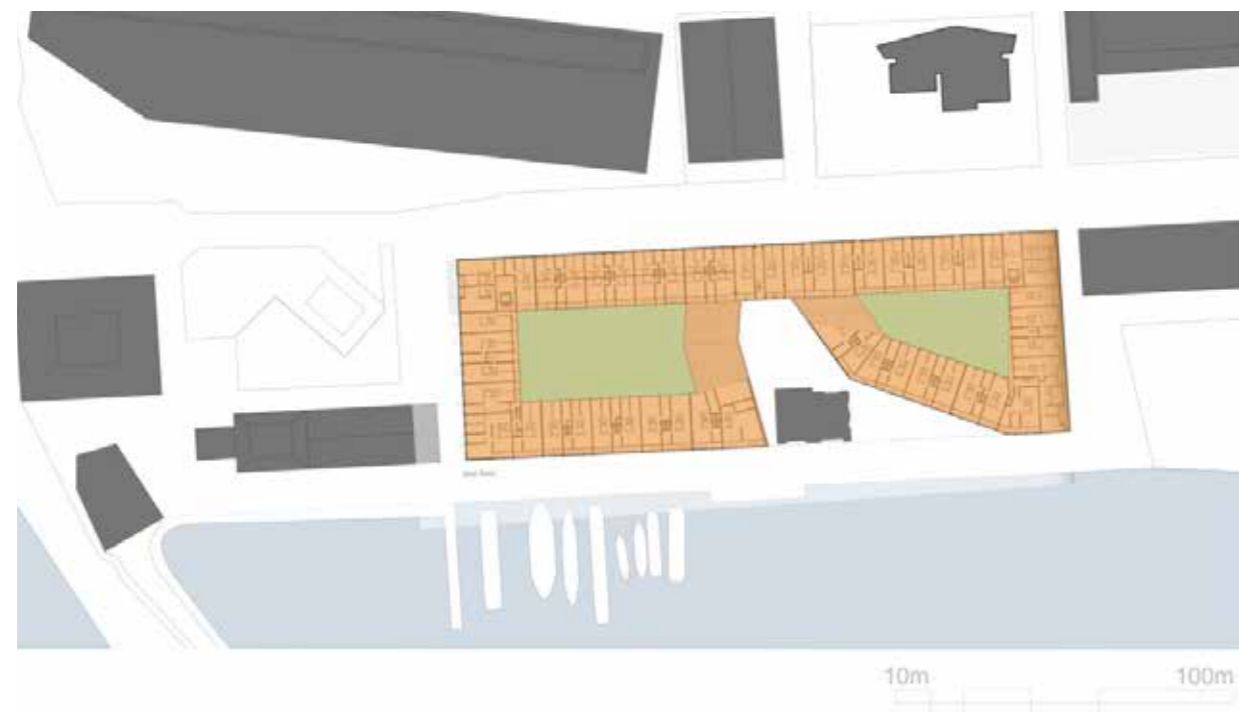

Density Comparison table

	Piraeus
Net Density (dwellings per hectare) "The ratio of the number of dwellings to the area of land they occupy (precinct or a block), including internal public streets and half of the width of adjoining streets that provide access to the dwellings"	221
Site Density (dwellings per hectare) "The ratio of the number of dwellings to the area of the site they occupy"	289
Habitable Rooms (habitable rooms per hectare)	-
Floor / Space Ratio "The floor space ratio of buildings on a site is the ratio of the gross floor area of all buildings within the site, to the site area"	4.65:1
Footprint (%)	69%
Rise (Storeys)	4-9
Site Area	10550m ²

(McInerney, 2014)
 Figure 22

5.6.2 Amsterdam Docklands

Dwelling plot organization - Eastern Docklands

Borneo 12

The average dwelling plot dimensions are : 5m*16m / 16,4'x 52,5' (860sf), which as a comparison is approximately quarter of a traditional lot in Vancouver.

On each lot, site coverage is limited as 30% of the surface is required to be void in order to enhance natural light exposition. Almost all houses are 3-storey high and arranged in rows to face the street.

The FSR (Floor Space Ratio) is unusually high for an individual housing program, between 2.5 and 3.0. (Roux-Delagarde, n.d.)



(West8, 2002).
Figure 24

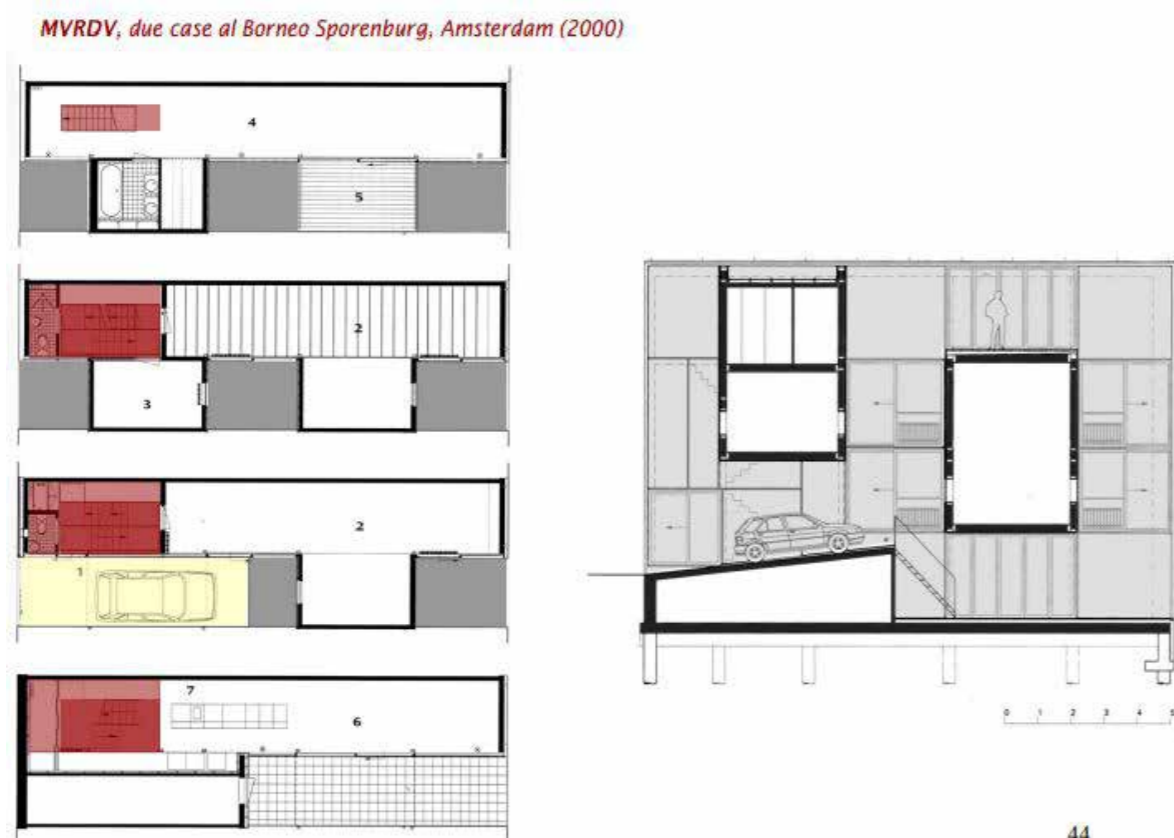

44

(Roux-Delagarde, n.d.)
Figure 23



(West8, 2002).
Figure 25

5.6.2 Amsterdam Docklands

Ijburg Urban Planning approach

Figure 26 depicts the process of master planning a mixed use courtyard styled block which could be moulded and adapted to meet a FAR 3-5.

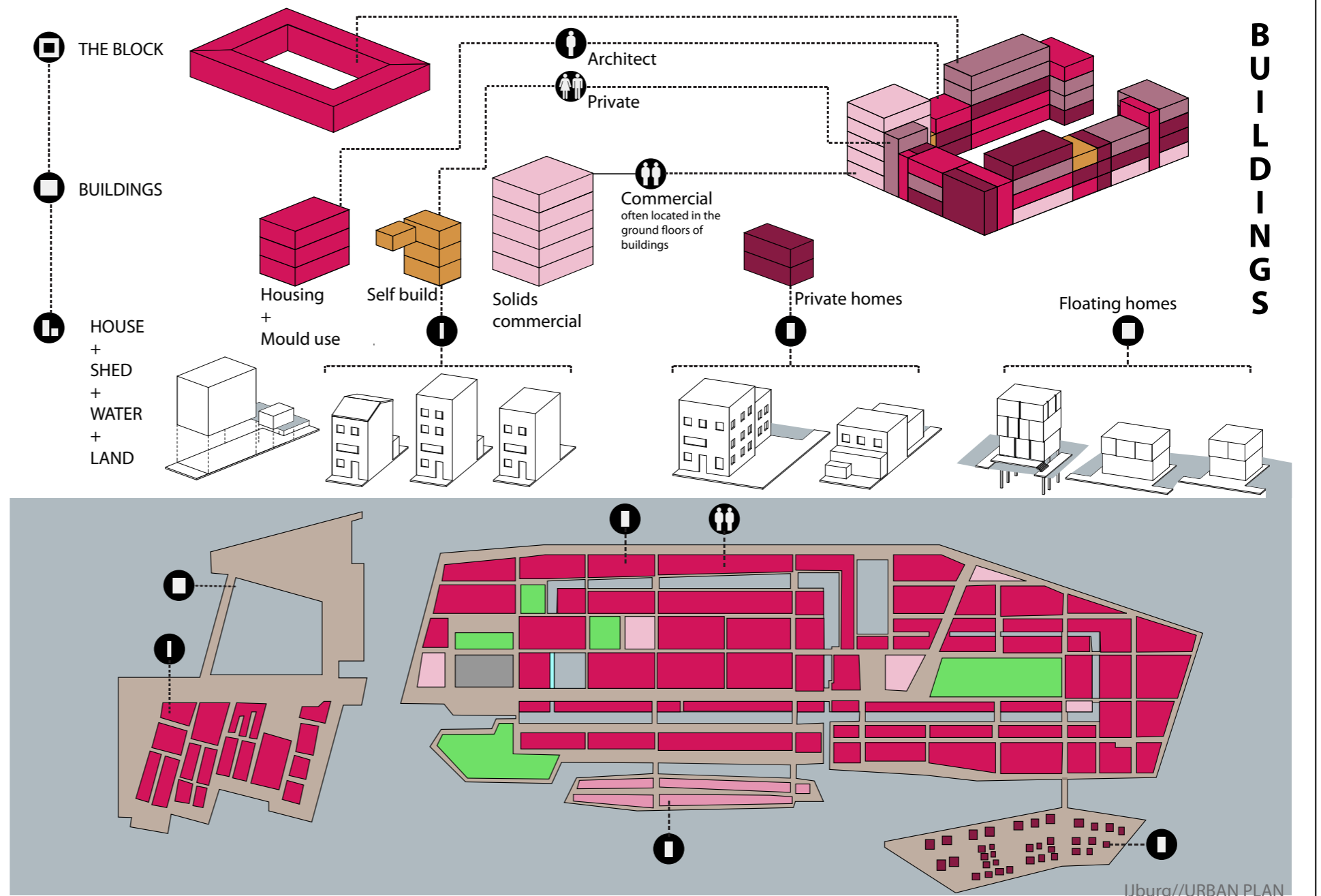

Ijburg/URBAN PLAN

(Graafland, 2012)

Figure 26

5.6.3 Mirador Apartments, Madrid, Spain

This project depicts an alternate approach to the podium tower solution. Through this design P.O.S is created and a 3D city formed. 'Mirador is a collection of mini neighbourhoods stacked vertically around a semi-public sky-plaza. The building acts as a counterpoint against the massive uniformity of the surrounding housing blocks. It frames the distant landscape of the Guadarrama Mountains through a large 'look out' located 40 metres above the ground. This also provides outdoor space and community garden for the occupants of building, monumentalities public life and space' (MVRDV, 2005).

Metric Values -

Floor area Ratio - 2.94

Density: Dwellings per Hectare - 67.9

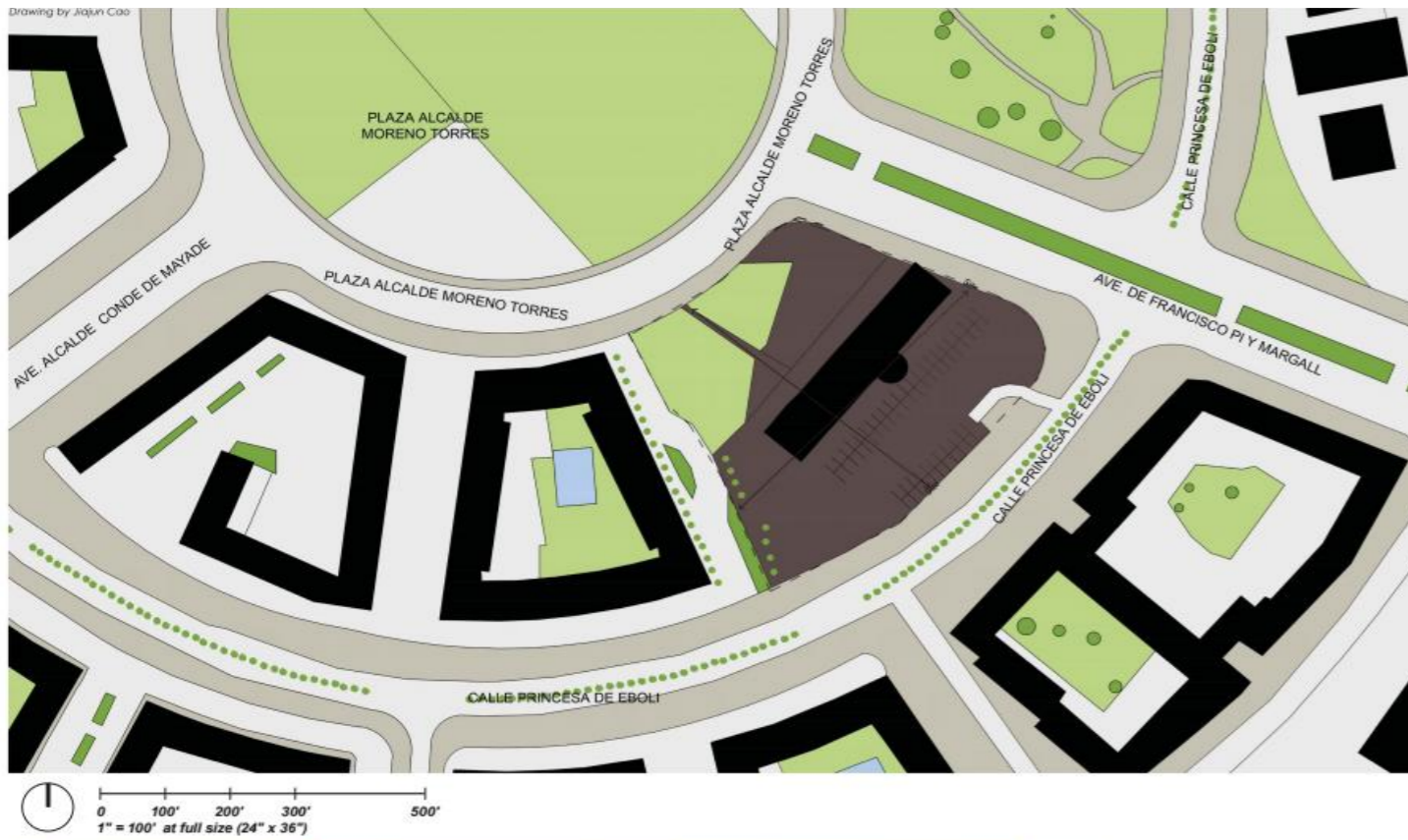

(Pizzi, 2017)
Figure 27

5.6.3 Mirador Apartments, Madrid, Spain

Alternative approach to our Proposal?

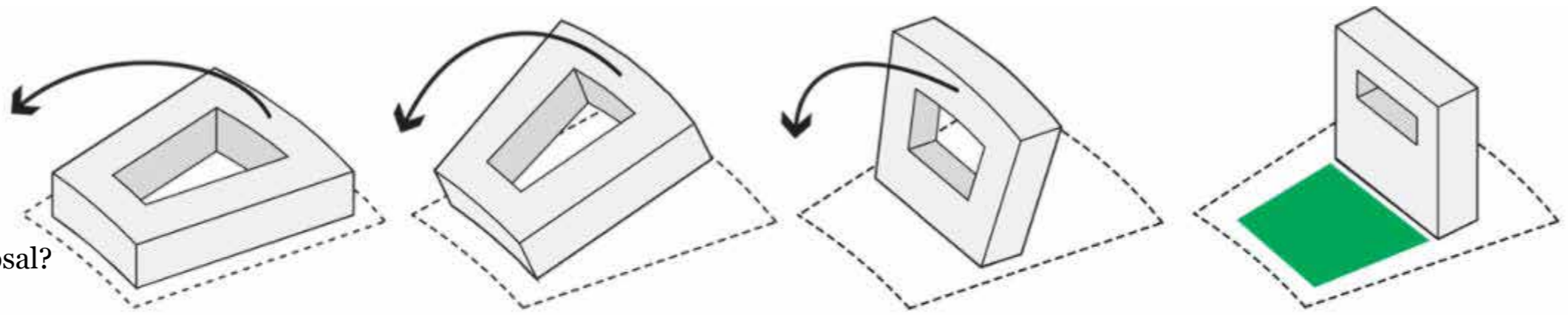

(MVRDV, 2005)

Part-Whole Relationships

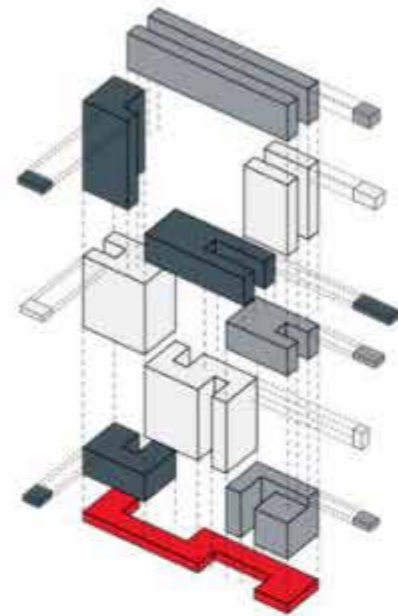

Thresholds + Porosity

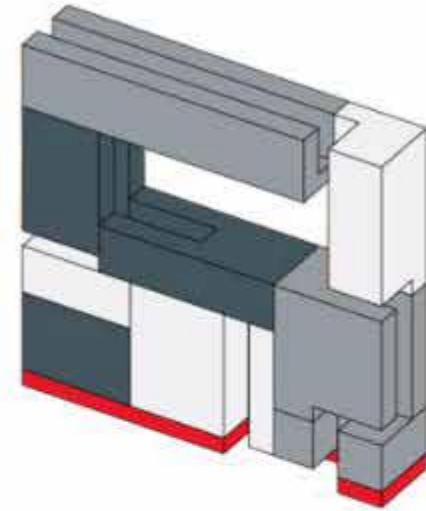

Access + Circulation

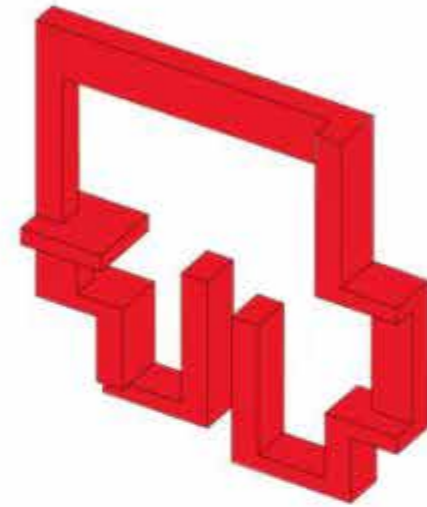

Light + Transparency

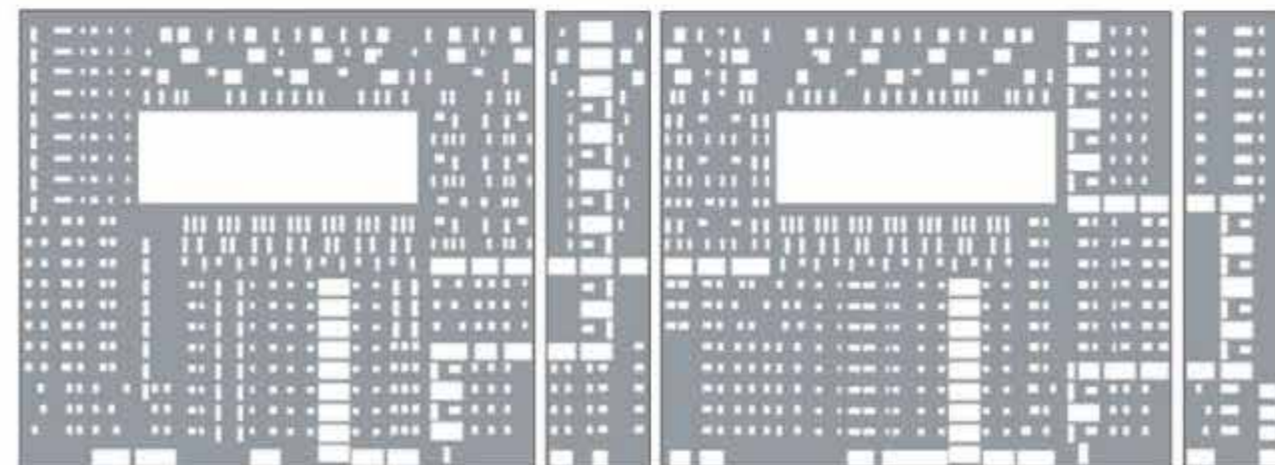

(MVRDV, 2005)
Figure 28

5.6.4 Design Excellence

Design competitions are becoming increasingly popular and if undertaken successfully can improve market yield and provide a significant contribution to the design of the urban environment.

The objective of a design competition is to deliver a high standard of architectural, urban and landscape design – generally above and beyond that of a normal development project. It focuses on lifting the bar of urban design and creating better urban spaces which make a positive contribution to the public domain. The process generally involves 3 or 4 architectural firms submitting competing design schemes for a development, with a jury (or panel) deliberating on the preferred scheme to determine whether it achieves design excellence.

Design competitions are linked to achieving design excellence, which can be used for a FAU uplift. An FAU uplift is not guaranteed through a design competition and all the relevant amenity controls must still be met.

Design competitions have been facilitated by the City of Sydney (CoS) for over 13 years. Design competitions are mandatory in new developments which meet certain criteria in the CoS, such as developments that have a height greater than 55m in Central Sydney, or a building higher than 25m outside Central Sydney and development having a capital value of more than \$100,000,000. Developers can also opt into a design competition even if they do not meet the above criteria, although before commencing a competition process, a Stage 1 consent would be required to establish the building envelopes and a design excellence strategy.

There are several different formats for design competitions, which range from publicly open design competitions to smaller invited competitions. The range of competitions include the following;

- Open architectural design competitions; where the public are invited to participate and expressions of interest are sought with a prize being offered for the winning scheme;
- Invited architectural design competition; with a minimum of five architectural entries competing for the project, with each firm remunerated during the competition phase and a jury of 4-6 persons deciding on the winning scheme; and
- Design alternatives process, which involves at least three architectural firms competing for the project with each firm remunerated during the competition phase and a panel of at least 3 persons deciding on the winning scheme.

A competition strategy for Fisherman's Bend could assist in providing a design driven methodology whilst still maintaining the FAR's. Certainly the Sydney experience shows when multiple architectural practices consider multiple architectural and urban propositions an enhanced urban realm is created. The other by product of the competitive process is the rise of emerging younger practices and the possible collaborations created with more established practices.

6. Conclusion + Recommendations

6.1 Building separation within a site.

With some sites having the opportunity for multiple towers above podiums, building separation should be a mandatory control.

I agree with Leanne Hodyl's recommendations on buildings up to 30 metres. But suggest going further apart above 30 metres. Above 30 metres suggest using the NSW ADG control of 24 metres between habitable rooms/balconies, 18 metres between habitable and non-habitable rooms and 12 metres between non-habitable would be preferable. To encourage laneway activation and diverse typologies I am comfortable with a 6-metre separation between habitable and habitable rooms across a laneway.

I concur with Leanne Hodyl's condition that a permit cannot be granted to vary these conditions.

6.2 FAR/FAU's

I disagree with the proposition that a developer be allowed to build more floor area on a site above that mandated by the FAR. I think that the public benefit paradigm is hard to quantify and to manage. Community housing and facilities should be handled separately.

It is apparent from Adelise Pearson's Capacity Modelling (page 29 Lorimer Built Form Testing) that the effect of the additional floor space created by the FAU is detrimentally affecting the urban environment.

The only uplift mechanism that I would be comfortable with is the design excellence approach where by holding

a competition a developer may be awarded some uplift. The City of Sydney provides a good example of this. The policy objective is to 'support the creation of a precinct of design excellence.'

6.3 Carparking

The provision of parking in absence of public transport is creating carparking podiums with towers above. To suggest that carparking be future proofed at 3.8 metres floor to floor is an untested approach. Car parks don't easily convert to office/commercial uses. A control limiting carparking to a maximum of .5 cars/apartment is an appropriate control. Additional parking could be provided remotely prior to additional public transport being provided.

6.4 Diversity

The design objectives in the planning scheme are 'to encourage a diversity of architectural styles and building typologies, to create a sense of place of architectural excellence, and an engaging and varied built form in response to the desired/preferred place and character.' These objectives are certainly laudable. The reality in the Lorimer Precinct, is that south of the proposed Lorimer Parkway a high rise precinct of towers on podiums will emerge (subprecinct area L4) and north of the proposed parkway a much more appropriate interesting scale precinct will emerge (subprecinct area L1, L2 and L3) The capacity modeling done by the City of Melbourne certainly shows some development diversity in subprecinct L1, L2 and L3. As mentioned in my evidence the European courtyard block model would achieve similar densities. It is my opinion that to achieve the policy objectives

there should be more definitive envelopes in much greater detail than those provided in DDO67. Again, the City of Sydney Ashmore and Green Square DCP/LEP envelopes could provide some guidance here.

6.5 Local Character

The Fishermans Bend Urban Renewal policy is to accommodate 80,000 residents and some 40,000 jobs becoming Australia's largest greenstar community. It is still unclear in all the documents provided what the vision, look and feel of Fisherman's Bend is. This needs to be more articulated and visualized if Fisherman's Bend isn't to become another South Bank.

6.6 Lorimer Precinct Masterplan.

The aspirational vision for Lorimer states 'A vibrant, mixed-use precinct close to the Yarra River and connected to Melbourne's CBD, Docklands and emerging urban renewal areas.'

It is surprising that a greater emphasis of connectivity through Yarra's Edge to the Yarra has not been provided. Visual and physical connections could certainly decant some of the Yarra Rivers amenity into Lorimer Precinct. (see figure 12). It is surprising that in all the planning maps and overlays Yarra's Edge is shown as an amorphous mass. While acknowledging that Lorimer Street is an important transport route to the Port, it is still relevant to analyse the development north of Lorimer street to 'knit' it back into the Lorimer Precinct.

7. Documents Studied

- Fishermans Bend Framework Draft
- Draft Planning Scheme Amendment GC 81 greater.
sydney/draft-greater-sydney-region-plan
- Ashmore Precinct Planning controls
- Ashmore Precinct LEP 2012
- Ashmore Precinct DCP
- Guidelines for Higher Density Development
- Better Apartments Draft Design Standards (BADDS)
- NSW Apartment Design Guide
- Amsterdam Housing (DIA Arie Grafland)

8. References

Amsterdaming (2011). Eastern Docklands of Amsterdam – Amsterdaming. [online]
Available at: <https://amsterdaming.com/2011/03/18/eastern-docklands-of-amsterdam/> [Accessed 9 Mar. 2018].

Architectureguide.nl. (1996). architectureguide.nl - Urban Design KNSM-eiland, Amsterdam. [online]
Available at: http://www.architectureguide.nl/project/list_projects_of_architect/arc_id/514/prj_id/1548 [Accessed 9 Mar. 2018].

Claus, F., van Dongen, F. and Schaap, T. (2001). IJburg
Fernández Per, A., Mozas, J. and Arpa, J. (2007). Dbook : density, data, diagrams, dwellings. Vitoria-Gasteiz: A+T.

Graafland, A (2012). Amsterdam Housing, Anhalt University Department 3.

Livingstone, M. (n.d.). [Landscape Architecture Study Tour with Professor Jack Ahern. [online] Courses.umass.edu.
Available at: <https://courses.umass.edu/latour/Netherlands/livingstone/index.html> [Accessed 9 Mar. 2018].

McInerney, K. (2014). Piraeus. [online] Big City Life: High Density Pleasure.
Available at: <https://highdensityliving.wordpress.com/2014/02/17/piraeus/> [Accessed 9 Mar. 2018].

State of Victoria (2017). Fishermans Bend Framework, The next chapter in Melbourne’s growth story.

Mecone (n.d.) Available at <http://mecone.com.au/>

MVRDV (2005). MVRDV - MIRADOR.
Available at: <https://www.mvrdv.nl/projects/mirador> [Accessed 9 Mar. 2018].

Pizzi, C. (2017). Site Design: Case Studies In Urban Housing. [online] Issuu.
Available at: https://issuu.com/christopherm.pizzi/docs/arh_240_fa16_case_studies_in_housin_f0565e5043854e [Accessed 9 Mar. 2018].

Roux-Delagarde, A. (n.d.). Amsterdam Row Houses. [online] Dynamic Cities Project.
Available at: <http://dynamiccities.org/amsterdam-row-houses/> [Accessed 9 Mar. 2018].

8, W. (2018). Borneo-Sporenburg. [online] West 8.
Available at: http://west8.com/projects/urban_design/borneo_sporenburg/ [Accessed 9 Mar. 2018].

This document was prepared by Koos De Keijzer with assistance from Rupert Reed + Arbella Winter-Cooke from DKO Architecture. I have made all the enquires that I believe are desirable and appropriate, and that no matters of significance which I regard as relevant have to my knowledge been withheld from the tribunal.

9. Instructions

Eliza M Bergin

From: Daniel Boden <Daniel.Boden@melbourne.vic.gov.au>
Sent: Tuesday, January 16, 2018 4:41 PM
To: koos@dko.com.au
Cc: Kate Dundas; Juliet Forsyth; ebergin@anthonymasonchambers.com.au
Subject: RE: Fishermans Bend Fee Proposal - UPDATED

Hi Koos,

Further to the initial brief set out in my email yesterday, we would like to expand this to cover the additional points highlighted below;

- Reviewing the Fishermans Bend Draft Framework and Planning Controls **and Fishermans Bend Urban Design Strategy (Hodyl & Co, Sept 2017) with specific reference to Lorimer precinct**
- Presenting your view on the role of Fishermans Bend in the context of city shaping and planning for Melbourne's growth over the next 30 years
- **Presenting your view of the appropriateness of the outcomes set out in the Urban Design Strategy from a development and design perspective**
- Outline specific local, national and/or international examples of recent urban renewal schemes that are predominantly in private ownership that have delivered good community infrastructure and quality design outcomes
- Commenting on the opportunity that Fishermans Bend presents to achieve best practice planning outcomes, touching on viability and the ability to achieve these in the FB context
- **You may also be called up to respond to developer submissions regarding the merits and appropriateness of the urban design and built form outcomes sought through the Urban Design Strategy and planning controls (such as height, setbacks, FARs etc)**

We request your availability for the first two weeks in April along with a declaration of any potential conflicts of interest you may have with this appointment.

Please contact me if you wish to discuss in more detail.

Best wishes,

Dan

Daniel Boden | Senior Strategic Planner - Urban Renewal | Urban Strategy

City of Melbourne | Council House 1, 200 Little Collins Street Melbourne 3000 | GPO Box 1603 Melbourne 3001
T: 03 9658 9878 | E: daniel.boden@melbourne.vic.gov.au
www.melbourne.vic.gov.au | www.melbourne.vic.gov.au/whatson

We value: Integrity | Courage | Accountability | Respect | Excellence

Please consider your environmental responsibility before printing this email.

From: Daniel Boden
Sent: Monday, 15 January 2018 3:52 PM
To: 'koos@dko.com.au'

1

Cc: Kate Dundas
Subject: Fishermans Bend Fee Proposal

Hi Koos,

Good to speak to you last week.

To confirm our discussion, we would like you to submit a fee proposal which provides for you preparing for and appearing at the Fishermans Bend Planning Review Panel, specifically;

- Reviewing the Fishermans Bend Draft Framework and Planning Controls
- Presenting your view on the role of Fishermans Bend in the context of city shaping and planning for Melbourne's growth over the next 30 years
- Outline specific local, national and/or international examples of recent urban renewal schemes that are predominantly in private ownership that have delivered good community infrastructure and quality design outcomes
- Commenting on the opportunity that Fishermans Bend presents to achieve best practice planning outcomes, touching on viability and the ability to achieve these in the FB context

I think that covers the main points (there's a substantial amount in each one) but please get in touch if you need any further clarification.

I will provide links to the relevant background documentation separately.

Look forward to hearing from you later this week.

Kind regards,

Dan

Daniel Boden | Senior Strategic Planner - Urban Renewal | Urban Strategy

City of Melbourne | Council House 1, 200 Little Collins Street Melbourne 3000 | GPO Box 1603 Melbourne 3001
T: 03 9658 9878 | E: daniel.boden@melbourne.vic.gov.au
www.melbourne.vic.gov.au | www.melbourne.vic.gov.au/whatson

We value: Integrity | Courage | Accountability | Respect | Excellence

Please consider your environmental responsibility before printing this email.

2