



Reaction to fire test report

Test standard: Ad-hoc test based off ISO 13785-1:2002







Test sponsor: Owners Corporation Plan Number [REDACTED]

System: Aluminium composite panel wall system representative of the in-situ wall located at [REDACTED]
[REDACTED] – Scenario 1 - Test 1

Job number: RTF220102

Test date: 10 March 2023 Revision: R1.0

Quality management

Revision	Date	Information about the report			
R1.0	30 June 2023	Description	Initial issue		
		Name Signature	Prepared by	Reviewed by	Authorised by
					
					

Contents

1.	Introduction	4
2.	Test specimen	4
2.1	Schedule of components	4
3.	Test procedure	9
4.	Test measurements and results	10
5.	Application of test results	18
5.1	Test limitations	18
5.2	Variations from the tested specimen	18
5.3	Uncertainty of measurements	18
Appendix A	Drawings of test assembly	19
Appendix B	Photographs	27

1. Introduction

This report documents the findings of three ad-hoc reaction to fire tests for an Aluminium composite panel (ACP) and glazing external wall cladding system performed on 10 March 2023. The test was based off some general requirements of ISO 13785-1:2002.

Warringtonfire performed the test at the request of the test sponsor listed in Table 1.

Table 1 Test sponsor details

Test sponsor	Address
Owners Corporation Plan Number [REDACTED]	[REDACTED]

2. Test specimen

2.1 Schedule of components

Table 2 describes the test specimen and lists the schedule of components. These were provided by the representatives of the test sponsor and surveyed by Warringtonfire. All measurements were done by Warringtonfire – unless indicated otherwise.

Detailed drawings of the test specimen are provided in Appendix A.

Table 2 Schedule of components

Item	Description														
Cladding															
1.	<table border="1"> <tr> <td>Item name</td> <td>ACP Panelling - casseted</td> </tr> <tr> <td>Product</td> <td>[REDACTED]</td> </tr> <tr> <td>Manufacturer/Supplier</td> <td>[REDACTED]</td> </tr> <tr> <td>Material</td> <td> <p>The panels – which were commercially sourced - consisted of two layers of aluminium sheets sandwiching a layer of polyethylene (PE) with fire-retardant core. The core was grey in colour. These were selected to replicate the panels found onsite at [REDACTED]</p> <p>Chemical analysis was conducted on both the site samples and the commercially available samples and the results were:</p> <p>[REDACTED] report number 22155 conducted by the analytical centre of UNSW showed that the core consisted of 73.4 % aluminium trihydrate, 0.6 % inert filler and 26 % PE.</p> <p>Site sample 1: report number 202212 sample #1 conducted by the analytical centre of UNSW showed that the core consisted of 69.8 % aluminium trihydrate, 1.6 % inert filler and 29 % PE.</p> <p>Site sample 2: report number 202212 sample #2 conducted by the analytical centre of UNSW showed that the core consisted of 69.5 % aluminium trihydrate, 1.6 % inert filler and 29 % PE.</p> <p>Refer to Appendix C for more detailed results.</p> </td> </tr> <tr> <td>Size</td> <td> <p>As shown in Figure 13.</p> <p>Thickness – 4 mm</p> <p>Skin thickness – 0.5 mm</p> <p>Depth – 150 mm (200 mm total cavity depth)</p> </td> </tr> <tr> <td>Batch</td> <td>FR U21709114-1</td> </tr> <tr> <td>Nominated mass densities</td> <td>Panel areal density – 7.5 kg/m²</td> </tr> </table>	Item name	ACP Panelling - casseted	Product	[REDACTED]	Manufacturer/Supplier	[REDACTED]	Material	<p>The panels – which were commercially sourced - consisted of two layers of aluminium sheets sandwiching a layer of polyethylene (PE) with fire-retardant core. The core was grey in colour. These were selected to replicate the panels found onsite at [REDACTED]</p> <p>Chemical analysis was conducted on both the site samples and the commercially available samples and the results were:</p> <p>[REDACTED] report number 22155 conducted by the analytical centre of UNSW showed that the core consisted of 73.4 % aluminium trihydrate, 0.6 % inert filler and 26 % PE.</p> <p>Site sample 1: report number 202212 sample #1 conducted by the analytical centre of UNSW showed that the core consisted of 69.8 % aluminium trihydrate, 1.6 % inert filler and 29 % PE.</p> <p>Site sample 2: report number 202212 sample #2 conducted by the analytical centre of UNSW showed that the core consisted of 69.5 % aluminium trihydrate, 1.6 % inert filler and 29 % PE.</p> <p>Refer to Appendix C for more detailed results.</p>	Size	<p>As shown in Figure 13.</p> <p>Thickness – 4 mm</p> <p>Skin thickness – 0.5 mm</p> <p>Depth – 150 mm (200 mm total cavity depth)</p>	Batch	FR U21709114-1	Nominated mass densities	Panel areal density – 7.5 kg/m ²
Item name	ACP Panelling - casseted														
Product	[REDACTED]														
Manufacturer/Supplier	[REDACTED]														
Material	<p>The panels – which were commercially sourced - consisted of two layers of aluminium sheets sandwiching a layer of polyethylene (PE) with fire-retardant core. The core was grey in colour. These were selected to replicate the panels found onsite at [REDACTED]</p> <p>Chemical analysis was conducted on both the site samples and the commercially available samples and the results were:</p> <p>[REDACTED] report number 22155 conducted by the analytical centre of UNSW showed that the core consisted of 73.4 % aluminium trihydrate, 0.6 % inert filler and 26 % PE.</p> <p>Site sample 1: report number 202212 sample #1 conducted by the analytical centre of UNSW showed that the core consisted of 69.8 % aluminium trihydrate, 1.6 % inert filler and 29 % PE.</p> <p>Site sample 2: report number 202212 sample #2 conducted by the analytical centre of UNSW showed that the core consisted of 69.5 % aluminium trihydrate, 1.6 % inert filler and 29 % PE.</p> <p>Refer to Appendix C for more detailed results.</p>														
Size	<p>As shown in Figure 13.</p> <p>Thickness – 4 mm</p> <p>Skin thickness – 0.5 mm</p> <p>Depth – 150 mm (200 mm total cavity depth)</p>														
Batch	FR U21709114-1														
Nominated mass densities	Panel areal density – 7.5 kg/m ²														
2.	<table border="1"> <tr> <td>Item name</td> <td>Back-pan</td> </tr> </table>	Item name	Back-pan												
Item name	Back-pan														

Item	Description	
	Product	Nominally 0.9 mm thick Galvabond sheet measured 0.6 mm
	Supplier	██████████
	Material	Galvanised steel
	Batch	Unknown
	Size	Measured: 1160 mm wide × 3700 mm tall, 0.6 mm thick – in segments.
Glazing		
3.	Item name	Double glazing
	Material	IGU-5 mm 'Bite' / 6 mm CLEAR HEAT STRENGTHENED / 6.76 mm CLEAR LAMINATE
	Size (nominal)	1188 mm wide × 1800 mm tall × 5 mm/6 mm/6.76 mm with a 12 mm black spacer.
	Manufacturer/Supplier	██████████ - AUSTECH GLASS SYSTEMS P/L
	Batch	188406 - 330200036/1
4.	Item name	Single glazing
	Material	6 mm toughened glass
	Size (nominal)	1182 mm wide × 1800 mm tall × 6 mm thick
	Manufacturer/Supplier	██████████ AUSTECH GLASS SYSTEMS P/L
	Batch	188416 - 330200039/1
Framing		
5.	Item name	Test rig frame - 90 × 90 SHS and 200 × 90 PFC frame
	Size	90 mm × 90 mm × 5 mm thick and 200 mm × 90 mm × 10 mm thick – refer to Figure 12.
6.	Item name	Aluminium curtain wall transom/mullions (rectangular hollow sections) – framing
	Size	65 mm to 70 mm wide × 116 mm deep × 3 mm thick.
	Manufacturer/Supplier	Capral Aluminium
7.	Item name	Aluminium angles - framing
	Size	25 mm wide × 50 mm deep × 3 mm thick
	Manufacturer/Supplier	Rapid Aluminium
8.	Item name	Aluminium angles – for middle double back-pan unit.
	Size	25 mm wide × 50 mm deep × 3 mm thick
	Manufacturer/Supplier	Rapid Aluminium
	Installation	Used to secure the secondary back-pan in the within the middle module. The angle was screw fixed to both the back-pan (item 2) and the aluminium framing (item 6) using screws (item 18).
9.	Item name	Aluminium stiffener - framing
	Size	3 mm thick × 150 mm deep
	Manufacturer/Supplier	Rapid Aluminium
10.	Item name	Curtain wall bracket
	Size	150 mm deep (7 mm thick) × 75 tall (10 mm thick) × 100 mm wide
	Installation	Used to secure the 3 modules to the test rig using tek screws.

Item	Description	
17.	Item name	Penetration sealant
	Product name	Firesound™
	Manufacturer/Supplier	HB Fuller
	Usage	Used between the back-pans (item 2) and the aluminium framing (item 7).
Fixings		
18.	Item name	Tek screws SDS – zinc coated steel – for fixing the back-pan
	Size	10g × 24 mm long
	Installation	Used to fix aluminium angles (item 8) to the aluminium frame (item 6) at max. 500 mm centres
19.	Item name	Wafer head screws – zinc coated steel
	Size	10g × 16 mm long
	Installation	Used to fix aluminium angles (item 8) to the aluminium frame (item 6) at max. 500 mm centres
20.	Item name	Wafer head screws – zinc coated steel
	Size	10g × 20 mm long
	Installation	Used to fix the penetration backing plate (item 12) to the back-pan (item 2) of the central module.
21.	Item name	Wafer head screws – zinc coated steel
	Size	10g × 21 mm long
	Installation	Used to fix ACP (item 1) to the aluminium stiffener (item 9) – four per corner.
22.	Item name	Aluminium rivets
	Size	Ø4 mm
23.	Item name	Fast-fix washers and pin weld (to hold insulation)
	Size	115 mm × 3 mm pins and 25 mm × 25 mm fast fix washers.
24.	Item name	Tek screws for curtain wall bracket
	Size	14 g × 35 mm long
25.	Item name	Tek screws for smoke seal to false slab i.e. C-Purlin
	Size	14 g × 35 mm long
Installation method		
Test rig:	The test rig frame (item 5) was the main support for the test specimen, however, there were two C-purlin sections that acted as false slabs (200 mm tall). The test specimen, 3-off modules – interconnected through aluminium framing (item 6), was fixed to the test rig using curtain wall brackets (item 10) and fixings (item 24) – see Figure 14 & Figure 15. Each module extended from the bottom of the specimen to the top.	
Framing:	The main framing for the external wall was composed of aluminium extrusions (item 6) which were screw fixed together. Aluminium angles (item 8) – horizontal edges - and stiffeners (item 9) – on the vertical edges - were fixed to the aluminium framing (item 6), using wafer head screws (item 20) and aluminium rivets (item 22), respectively.	
Cladding:	<p>The front face of the specimen was cladded with cassetted ACPs (item 1), which were fixed to the aluminium stiffeners (item 9) and the aluminium angles (item 8) using aluminium rivets (item 22), 2-off at 300 mm centres. See Figure 13 for panel locations.</p> <p>The back side of the framing was closed off with steel back-pans (item 2) screw fixed (item 18) at 300 mm centres. PET insulation (item 13) was fixed to the back-pan using fast-fix washers and pin combinations (item 19) that were welded to the back-pan. The centre module had an extra back-pan behind the glazing (item 4). This was fixed to the aluminium framing (item 6) using screws (item 18) and aluminium angles (item 8). Foil-faced rockwool insulation (item 14) was inserted between the two back-pans (item 2) of the centre module.</p>	

Item	Description
Glazing	The glazing, both double (item 3) and single (item 4), were attached to the aluminium framing (item 6) as shown in Figure 13 to Figure 18 and Figure 19. The glazing was sealed around the perimeter with weather sealant (item 15).
Smoke seal	Smoke seal barrier (item 11) was attached to C-purlins of the test rig (item 5) with screw fixings (item 24) at approximate 600 mm centres. PET insulation (item 13) was installed into the 60 mm wide cavity above the barrier (item 12).
Penetration	The penetration went through holes in the single glazing (item 4) and back-pans (item 2) of the second module. These were fixed to the back-pan and the window with a steel sheet (backing plate), using screws and sealant and just sealant, respectively.

3. Test procedure

Table 3 details the test procedure for this reaction to fire test.

Table 3 Test procedure

Item	Detail
Statement of compliance	The ad-hoc test – which was based off ISO 13785-1:2002 - was performed to determine the reaction to fire performance of an external wall cladding when exposed to heat from a simulated external fire with flames impinging directly upon a façade. The test utilises a burner used in ISO 13785-1:2002 with the specimen mimicking the as-is construction of the façade.
Sampling / specimen selection	The laboratory was not involved in sampling or selecting the test specimen for the reaction to fire test. The results obtained during the test only apply to the test samples as received and tested by Warringtonfire.
Test duration	60 minutes
Instrumentation and equipment	<ul style="list-style-type: none"> • 21 mineral insulated metal sheathed (MIMS) Type K thermocouples with an overall diameter of 1.5 mm with the measuring junction insulated from the sheath were positioned 60 mm in front of the outer ACP face of the test specimen. Refer to Figure 1 for details on positioning. • The incident heat flux on the top of the specimen in line with the front face of test specimen was measured using a Schmidt-Boelter type heat flux gauge with a range of 0-100 kW/m². • The incident heat flux 500 mm behind the outer glazings – burner side and non-burner side – was measured using two Schmidt-Boelter type heat flux gauges with a range of 0-50 kW/m² and 0-20 kW/m², respectively. • The incident heat flux 80 mm behind the central glazing was measured using a Schmidt-Boelter type heat flux gauge with a range of 0-20 kW/m². • Temperatures above and below the cladding were measured by seven 100 mm × 100 mm × 0.7 mm plate thermocouples with mineral insulated metal sheathed (MIMS) Type K thermocouples with an overall diameter of 1 mm with the measuring junction electrically insulated from the sheath. The thermocouple hot junction was fixed to the geometric centre of the plate by a small steel strip made from the same material as the plate. The plate thermocouples included 97 mm × 97 mm × 10 mm inorganic insulation pads. Before the first use of the plate thermocouples, they were aged by being exposed to heat in a fire-resistance test furnace for 90 min under the standard temperature/ time curve. Refer to Figure 1 for details on positioning. • The fire source was a propane (95% purity) gas burner 1.2 m long × 0.1 m deep × 0.15 m tall. The burner was placed on the floor below the specimen with approximately 15 mm overlap with the ACP.
Test procedure	<ul style="list-style-type: none"> • At least two minutes of baseline data was collected prior to burner ignition. Temperature and heat flux data was collected at 5 s intervals. • The heat output from the burner was held at 300 kW for the 30 minutes. The burner was then turned off and data recorded for the next 30 minutes.
Test number	Test one of three.
Variation to test 2 and 3	<ul style="list-style-type: none"> • Different to the remaining two tests, the aluminium mullions between modules were not capped. This allowed heat from the bottom of the specimen to rise up through the mullion acting as a chimney. • Due to the incorrect positioning of the lower false slab, a 92 mm galvanised steel stud was used to get the correct height of the smoke seal.

4. Test measurements and results

The results from the tests are summarized below. Photographs of the specimen are included in Appendix B.

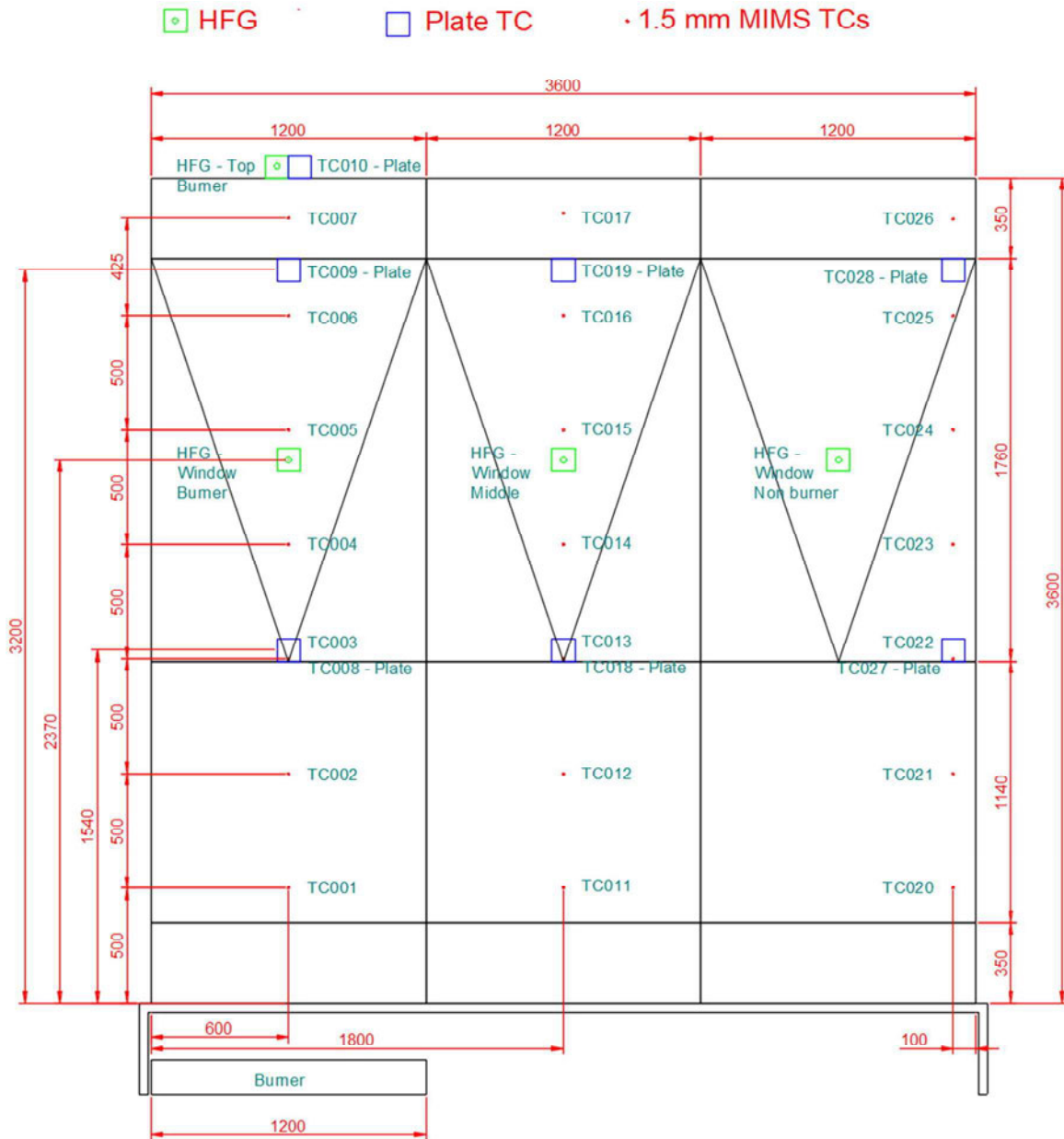

Figure 1 Instrumentation locations – front elevation

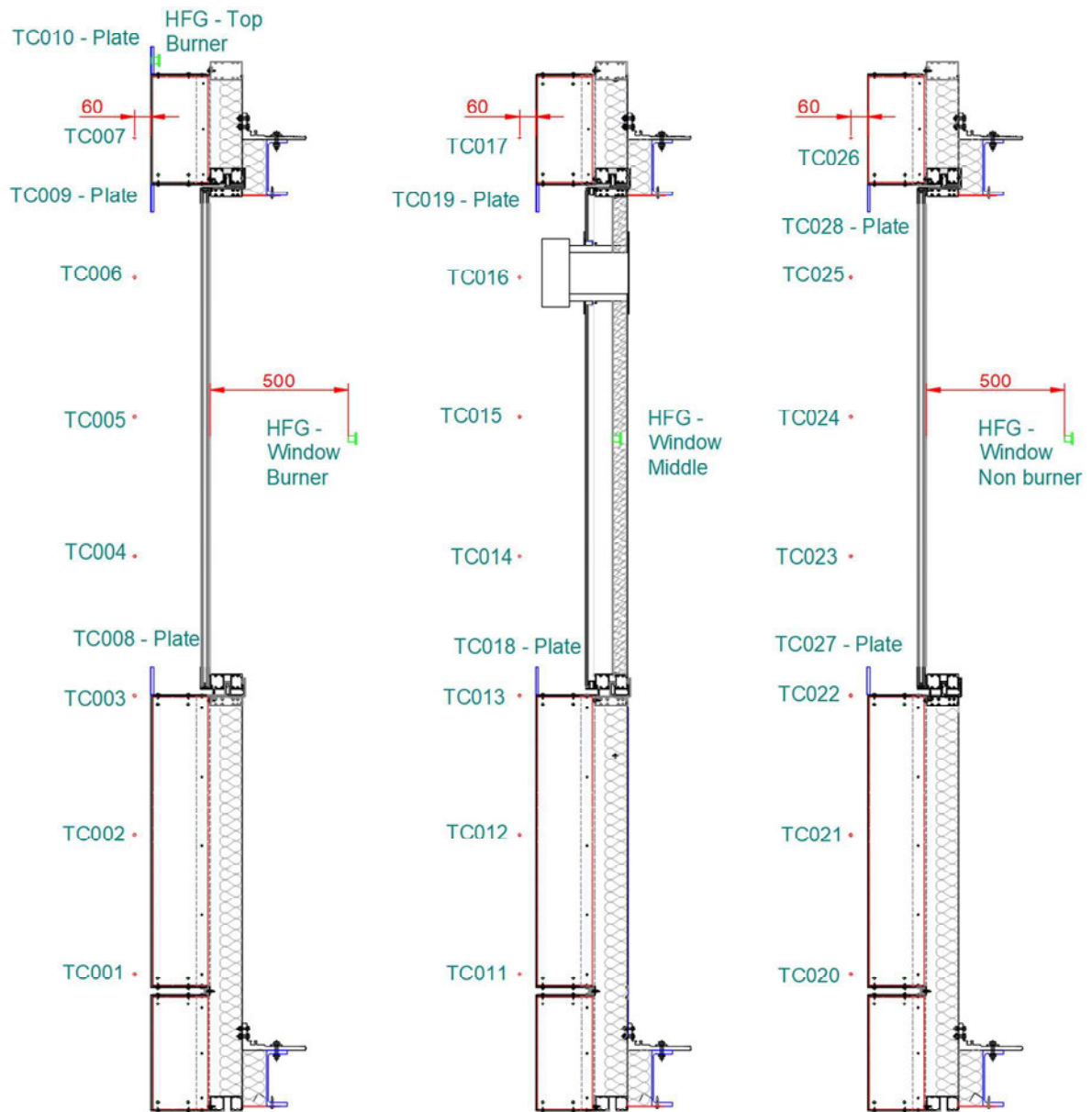

Figure 2 Instrumentation locations – sections

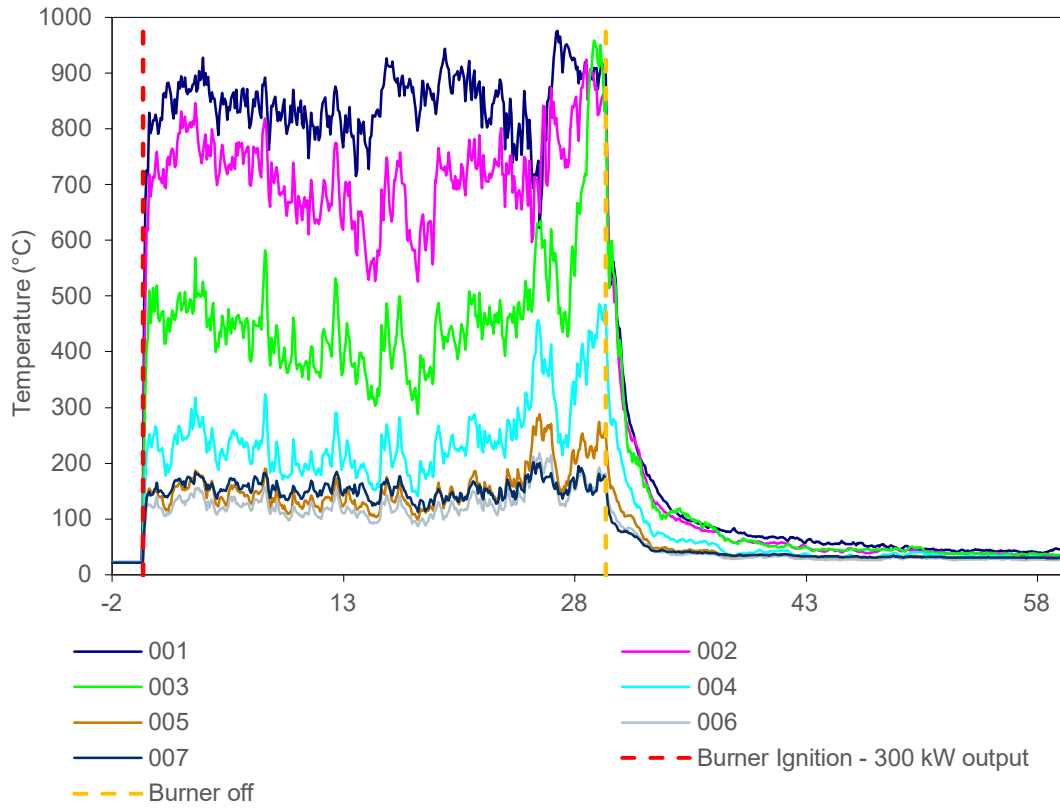

Figure 3 External temperature data collected by thermocouples placed 60 mm from the front face of the specimen - in-line with the burner.

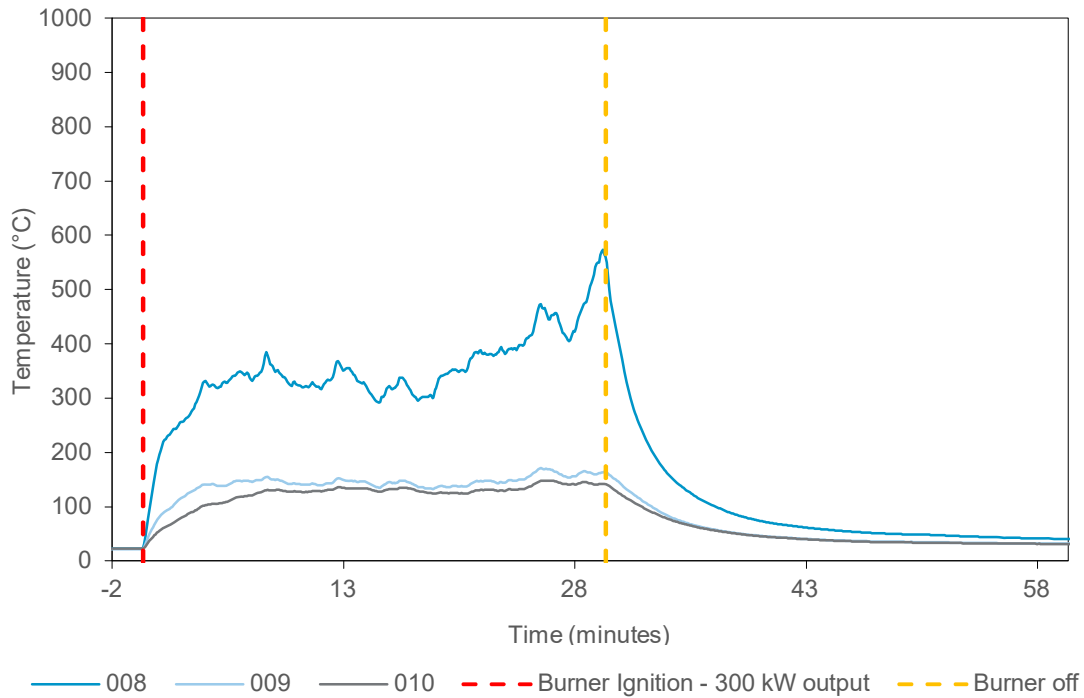

Figure 4 External temperature data collected by plate thermocouples in-line with ACP, above and below, respectively - in-line with the burner.

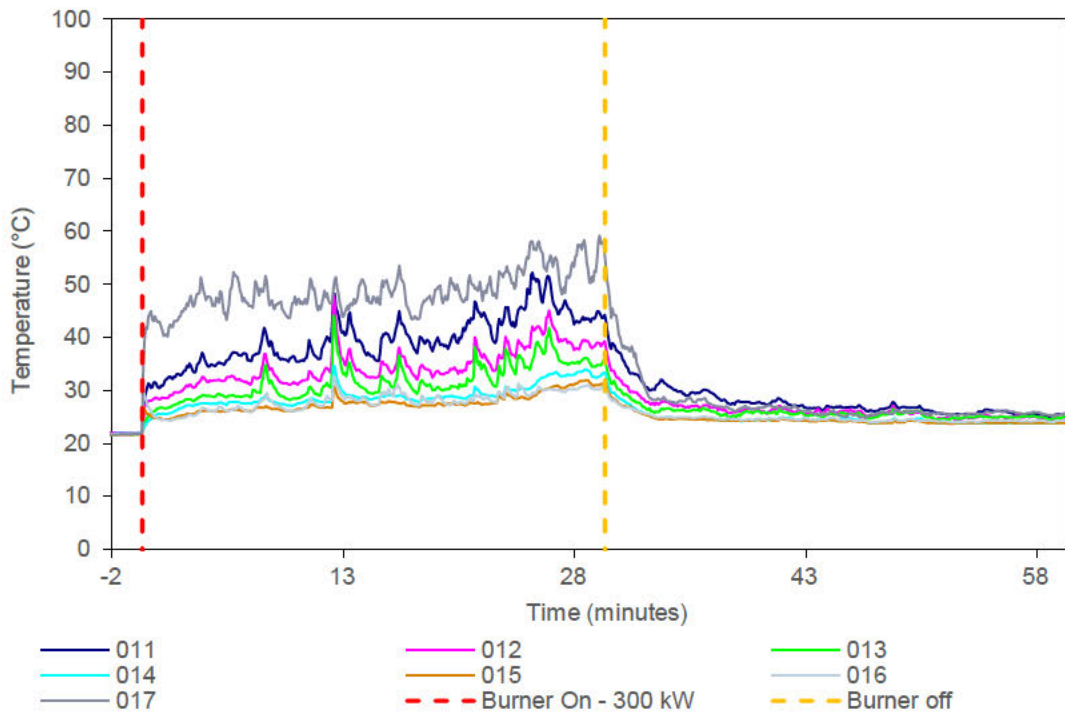

Figure 5 External temperature data collected by thermocouples placed 60 mm from the front face of the specimen – central module.

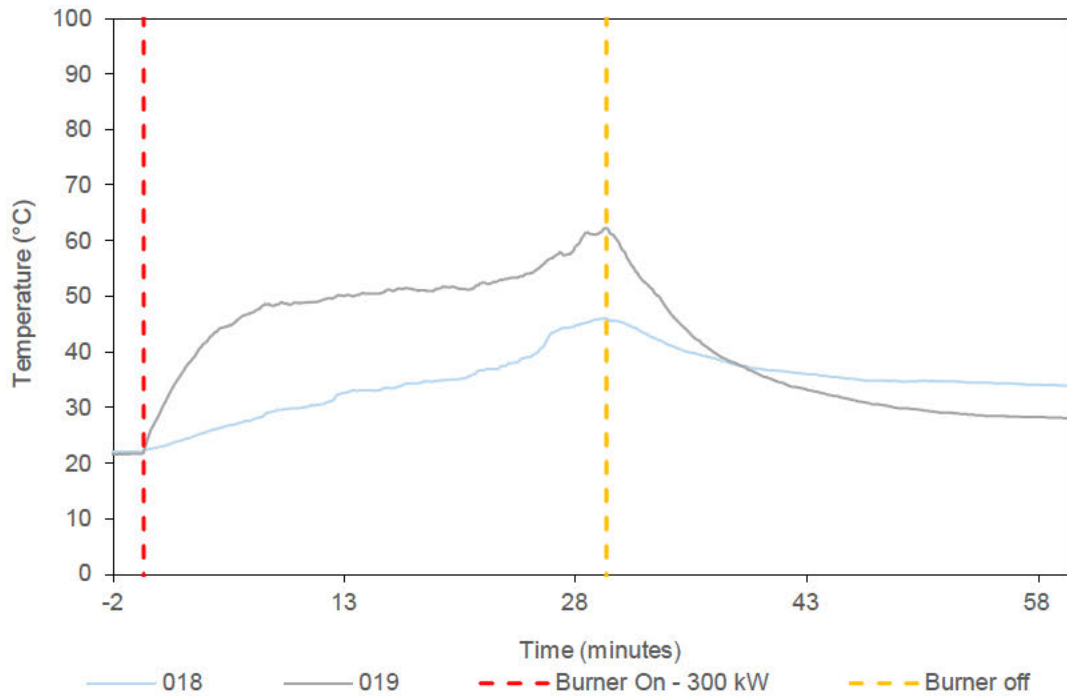

Figure 6 External temperature data collected by thermocouples in-line with ACP, above and below, respectively – central module.

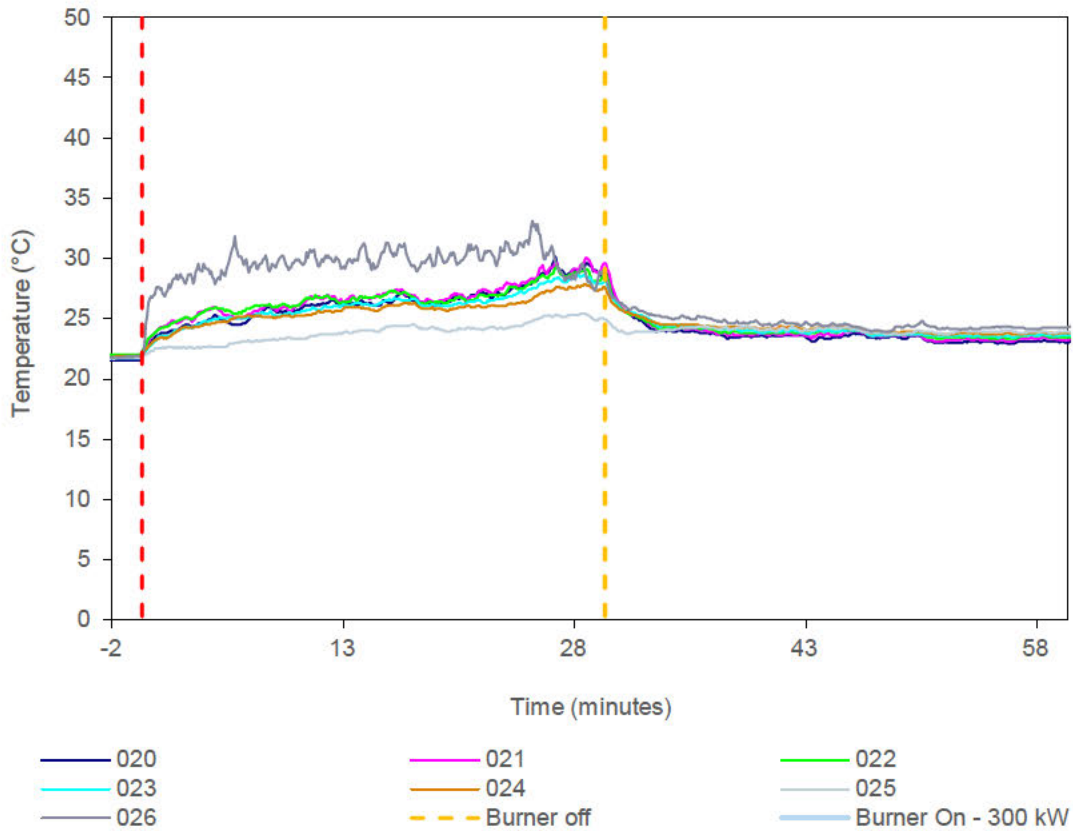

Figure 7 External temperature data collected by thermocouples placed 60 mm from the front face of the specimen – away from burner.

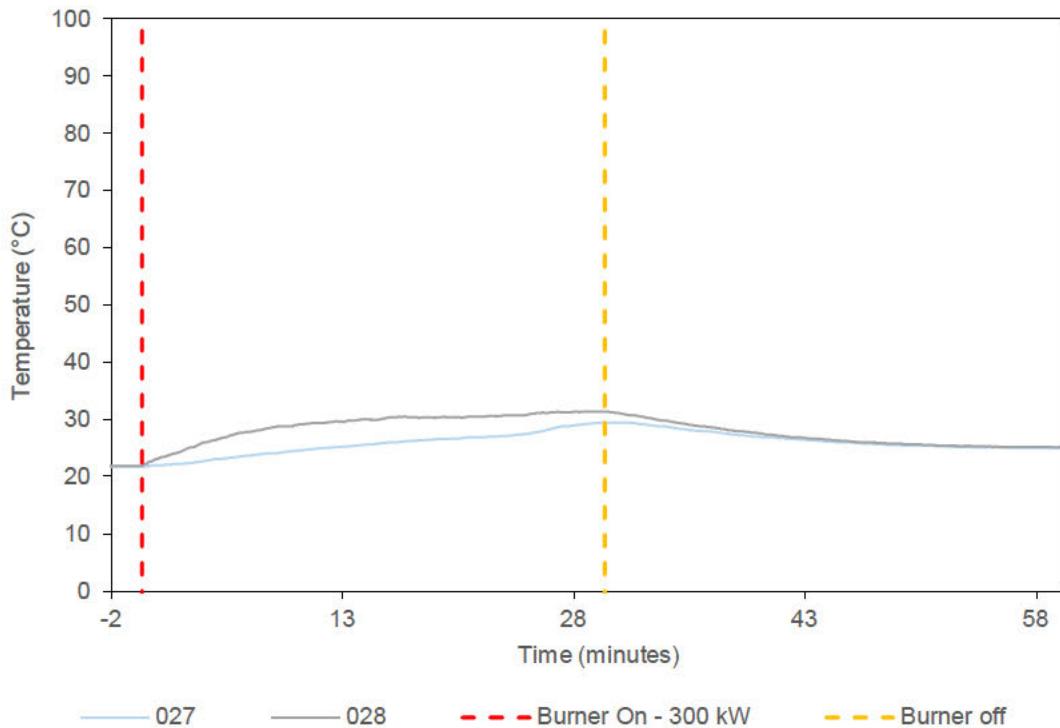

Figure 8 External temperature data collected by thermocouples in-line with ACP, above and below, respectively – away from burner.

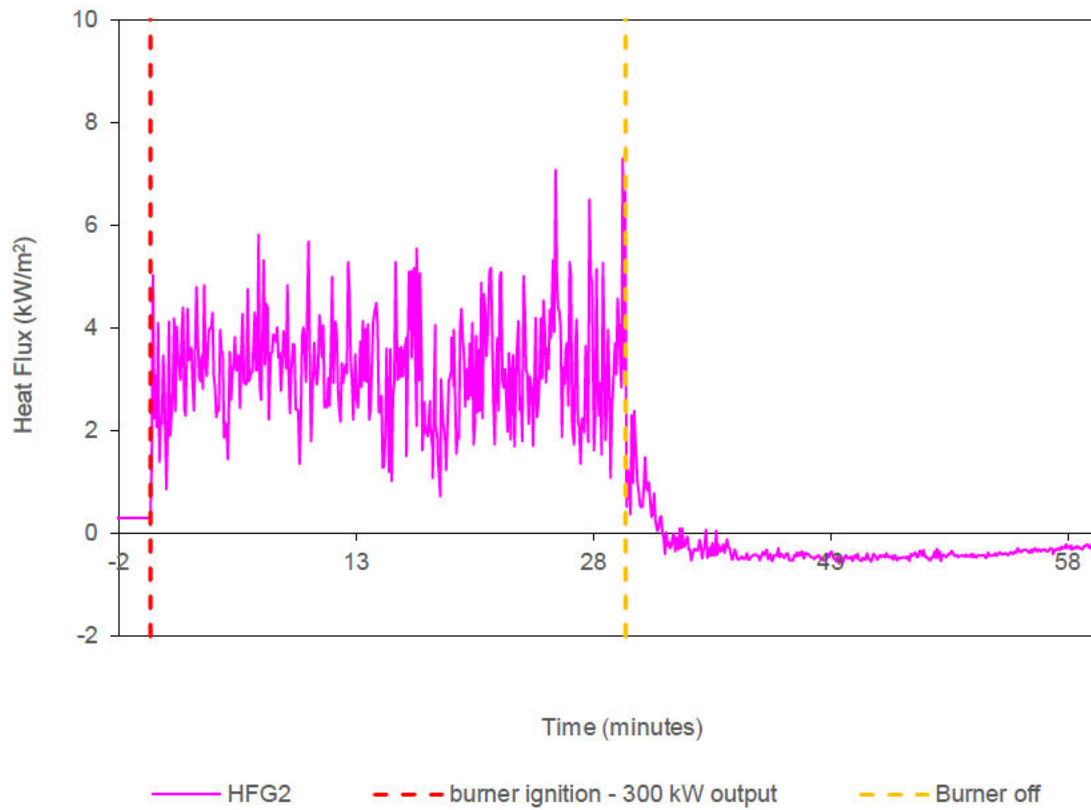

Figure 9 Heat flux data collected by heat flux gauge at the top of the specimen above the burner.

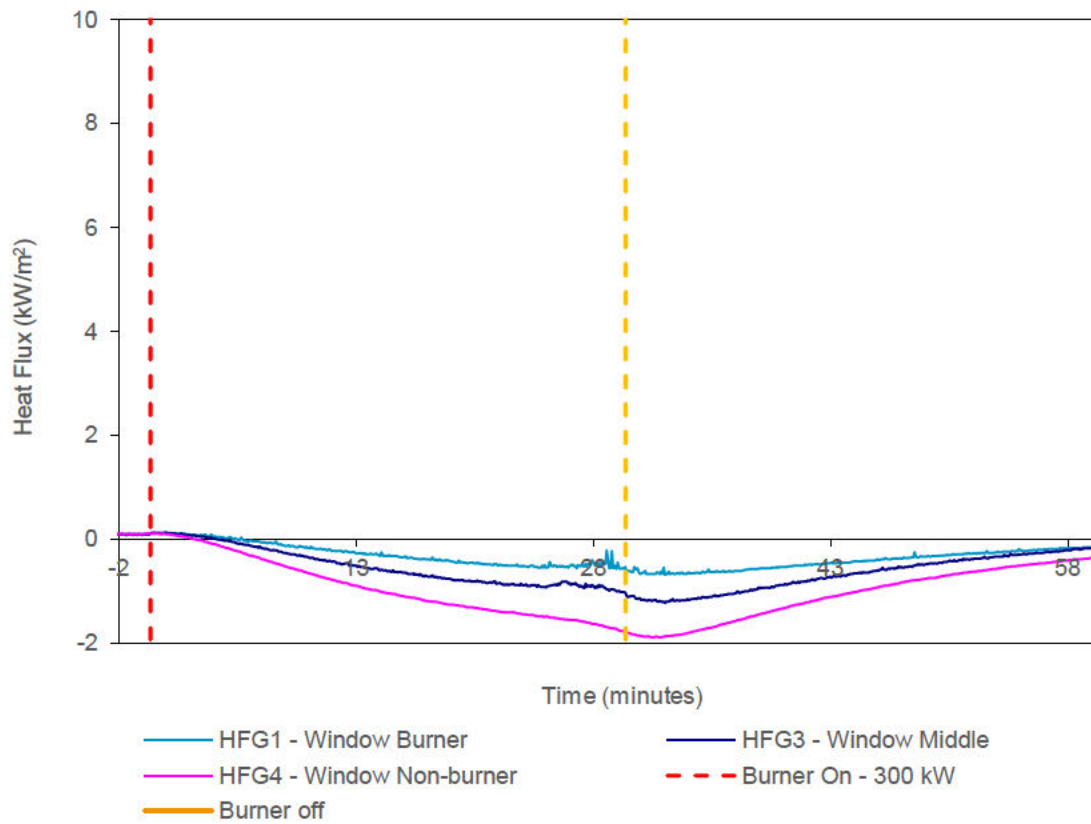

Figure 10 Emitted heat flux measured by heat flux gauges behind the glazing units.



Figure 11 Designation of section for the test observations.

Table 4 shows the observations of any significant behaviour of the specimen during the test. Figure 10 shows the panel and glazing designations sighted in the observations.

Video recordings were also taken of the test from approximately 4 metres in front of the specimen and from 2 metres on a 45 ° angle behind the specimen, however, the recordings were corrupted/could not be viewed. Extra test photos in the report have been supplied as a substitute.

Table 4 Test observations

Time		Observation
Min	Sec	
-2	00	Data collection started.
0	00	The reaction to fire test was started with the burner ignited with a heat output set at 300 kW.
0	44	Smoke was emitting at the top of the specimen via the aluminium mullion between sections 10 and 11.
1	07	Smoke was emitting at the top section 2.
1	23	Ash was floating in the air.
1	54	Sections 1 and 2 become black.
2	25	There was more smoke emitting at the top of the specimen via the aluminium mullion between sections 10 and 11.
2	50	Molten aluminium started to form and drip from the specimen.

Time		Observation
Min	Sec	
4	30	Smoke venting at the top of the specimen had increased.
5	23	There were smoke emissions from the joint between sections 4 and 7.
6	00	Fire started to spread slightly to section 2.
6	38	There was more dripping of aluminium from section 1.
7	18	Section 10 had discoloured.
8	20	Section 4 had begun melting and it had started to drip.
8	50	The glazing – section 7 – has started to discolour.
9	00	There was smoke from the back of section 4 beginning to emit.
12	00	There are smoke emissions from the back of section 1.
12	30	The ACP of section 2 has deformed slightly.
15	50	A part of the ACP of section 1 is hanging from the specimen.
17	46	Flaming from the specimen itself is occurring between sections 1 and 2.
19	50	The ACP of section 2 is deforming by bulging outward.
19	52	The ACP of section 1 is deforming by bulging outward.
20	50	There is horizontal fire propagation of 50 % of the section 2 ACP.
21	53	Flames are reaching halfway up section 7.
23	00	There is vertical flame spread halfway up section 2 left side.
25	16	The back-pan of section 1 has discoloured black.
26	00	There is a large amount of flaming within the cassetted ACP of section 1.
27	00	There is fire outside escaping the back-pan of the section 1 – unexposed side.
28	00	Flames have hit the bottom of section 10.
28	46	The cassetted ACP of section 4 has opened up.
28	50	There is flaming and flaming droplet coming through the back of section 1 – unexposed side.
29	30	There is more flaming and flaming droplets coming through the back of section 1. The smoke seal is on fire.
30	00	The burner was turned off.
30	10	The specimen was still burning and there was burning between sections 2 and 5.
32	21	The left side of the cassetted ACP collapsed.
33	27	There is fire at the left bottom edge of section 7. The sealant of the glazing is burning.
36	00	There is flaming droplets from the sealant of section 7.
36	30	There is flaming debris on the burner.
37	00	There is fire in the cavities of sections 1 and 4.
44	55	There is no fire on the unexposed side of the specimen.
45	00	There is still flaming in the section 4 cavity.
47	06	There are still smoke emissions from the top of the specimen between sections 10 and 11.
50	00	There is still flaming in the section 4 cavity.
51	00	There is still flaming debris on the burner.
54	00	There is no flaming in the section 4 cavity.
60	00	There was flaming debris on the floor below the specimen. The test was ended.

5. Application of test results

5.1 Test limitations

The results of these fire tests may be used to directly assess fire hazard, but it should be recognised that a single test method will not provide a full assessment of fire hazard under all fire conditions.

These results only relate to the behaviour of the specimen of the element of construction under the particular conditions of the test. They are not intended to be the sole criteria for assessing the potential fire performance of the element in use, and they do not necessarily reflect the actual behaviour in fires.

5.2 Variations from the tested specimen

This report details methods of construction, the test conditions and the results obtained when the specific element of construction described here was tested following the procedure outlined in Table 3. Any significant variation with respect to size, construction details, loads, stresses, edge or end conditions is not addressed by this report.

It is recommended that any proposed variation to the tested configuration should be referred to the test sponsor. They should then obtain appropriate documentary evidence of compliance from Warringtonfire or another accredited testing authority.

5.3 Uncertainty of measurements

Because of the nature of reaction to fire testing and the consequent difficulty in quantifying the uncertainty of measurements obtained from a reaction to fire test, it is not possible to provide a stated degree of accuracy of result.

Appendix A Drawings of test assembly

The drawings of the test assembly in Figure 12 to Figure 19 were provided by the representatives of Warringtonfire. Dimensions, unless specified, are in mm.

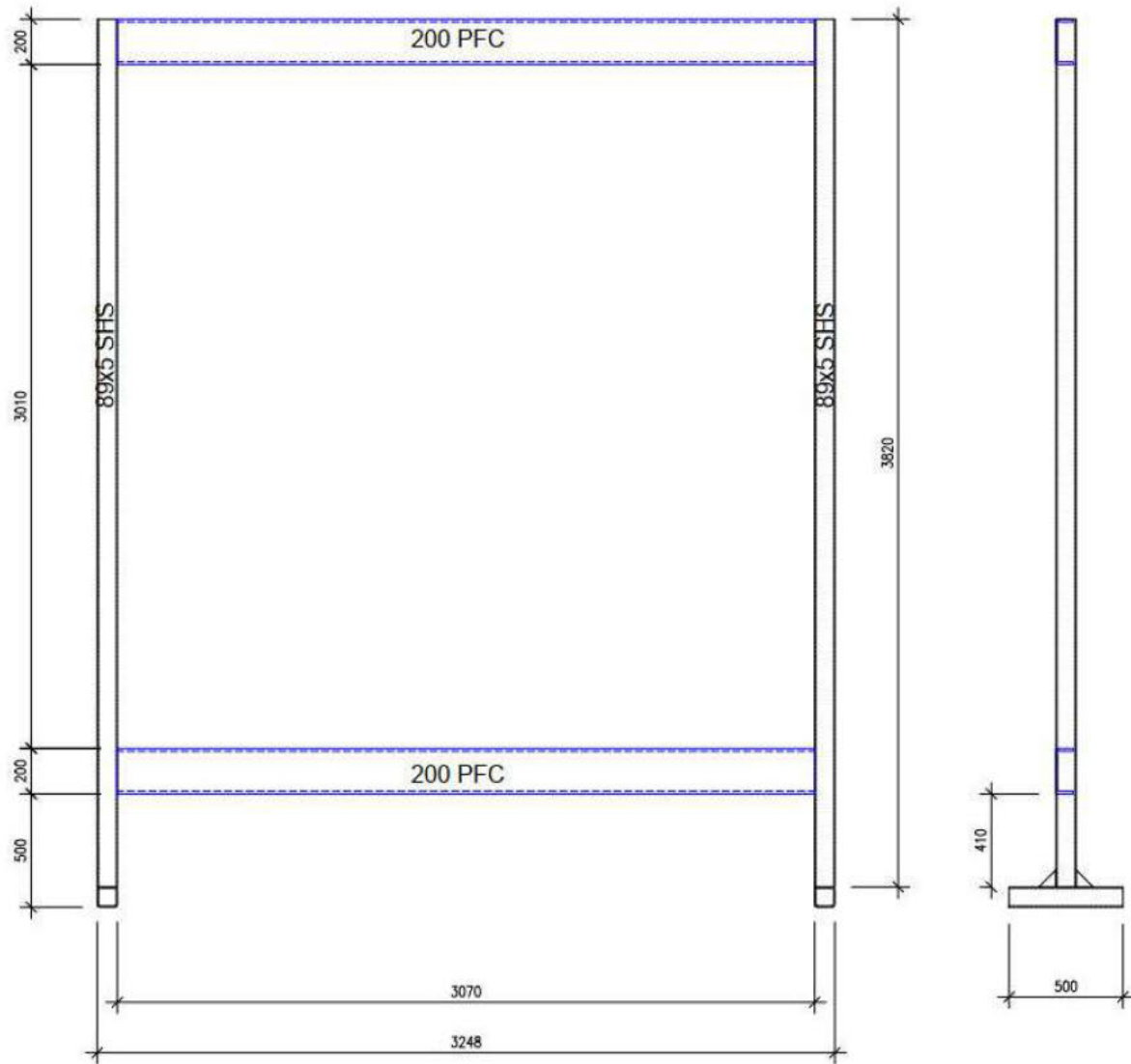

Figure 12 Elevation of rig support.

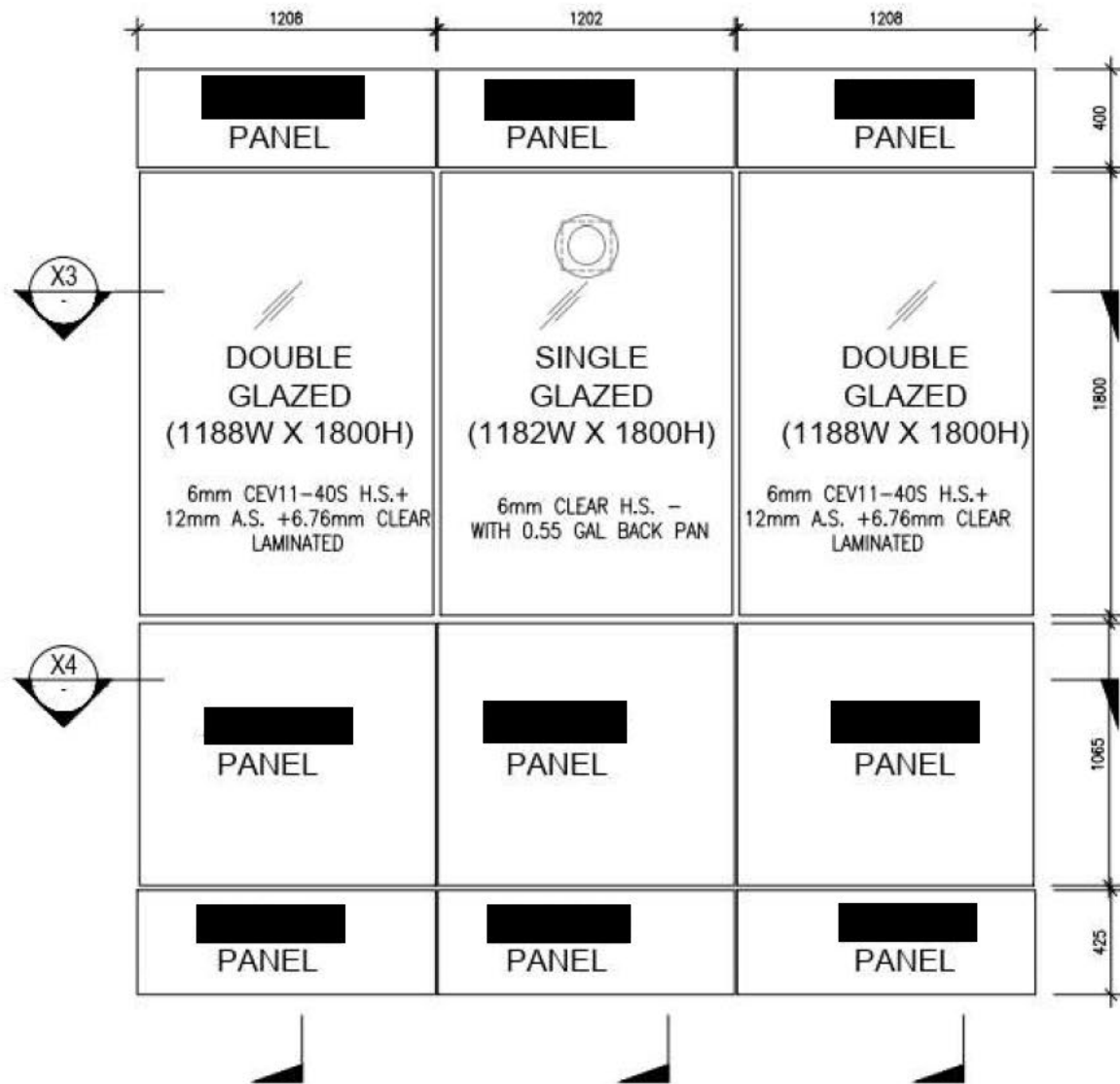

Figure 13 System assembly – Front view

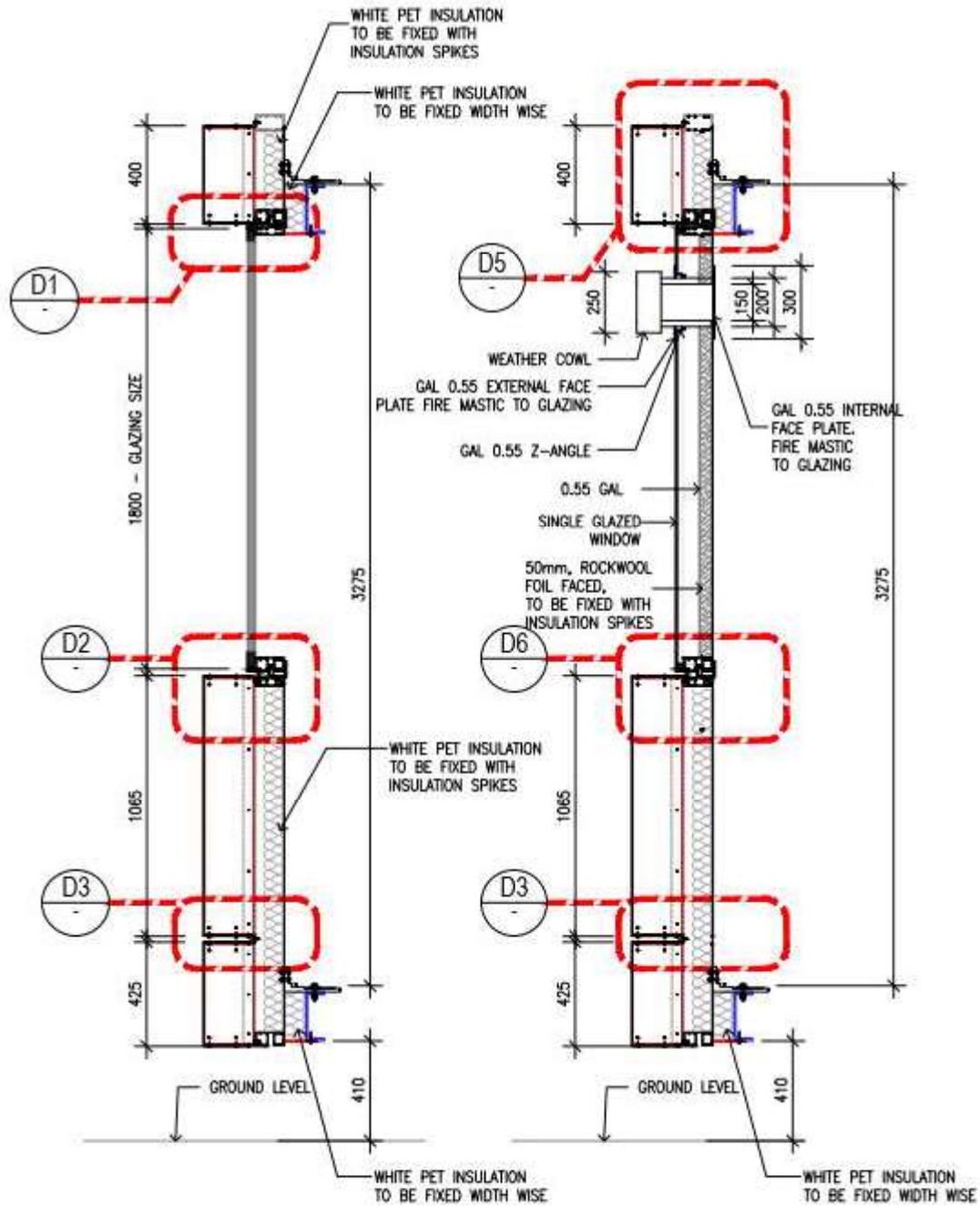

Figure 14 System assembly – vertical cross-sectional view.

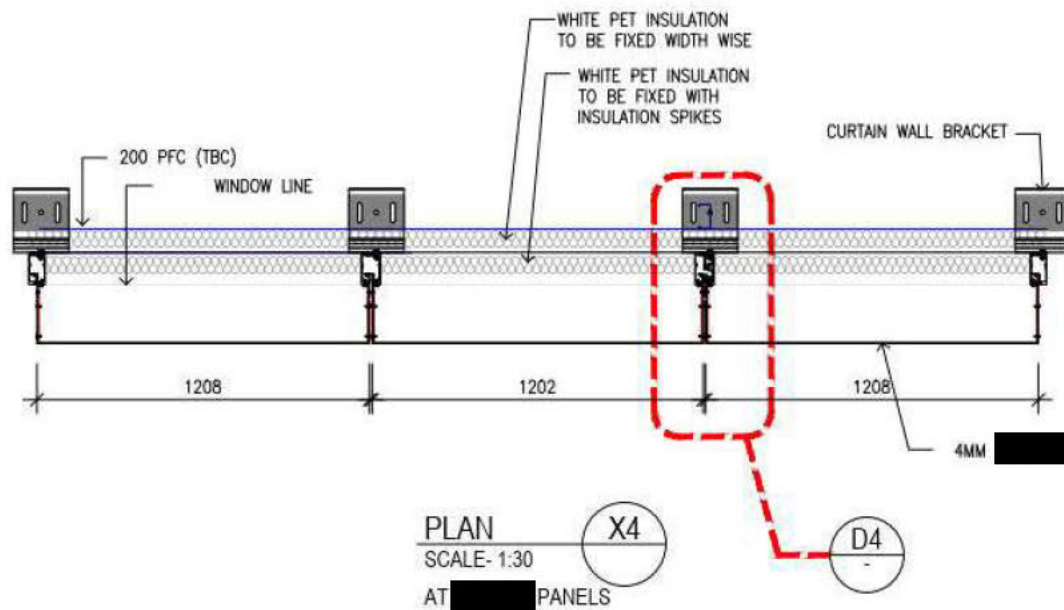
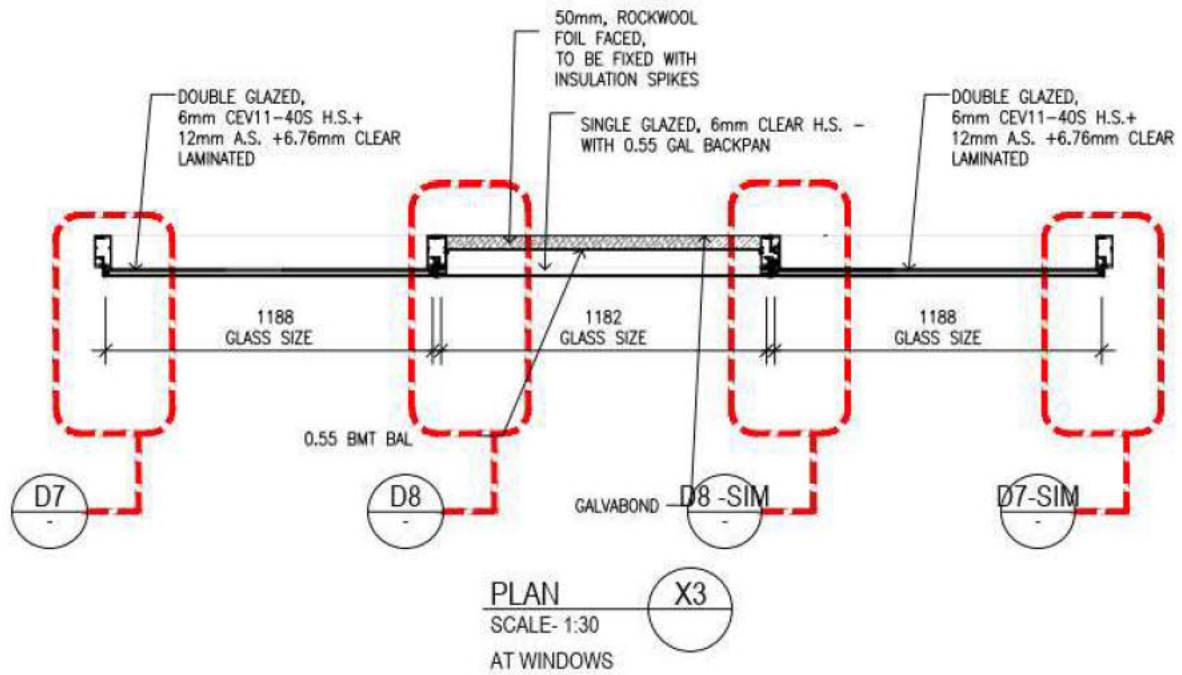

Figure 15 System assembly – vertical cross-sectional view.

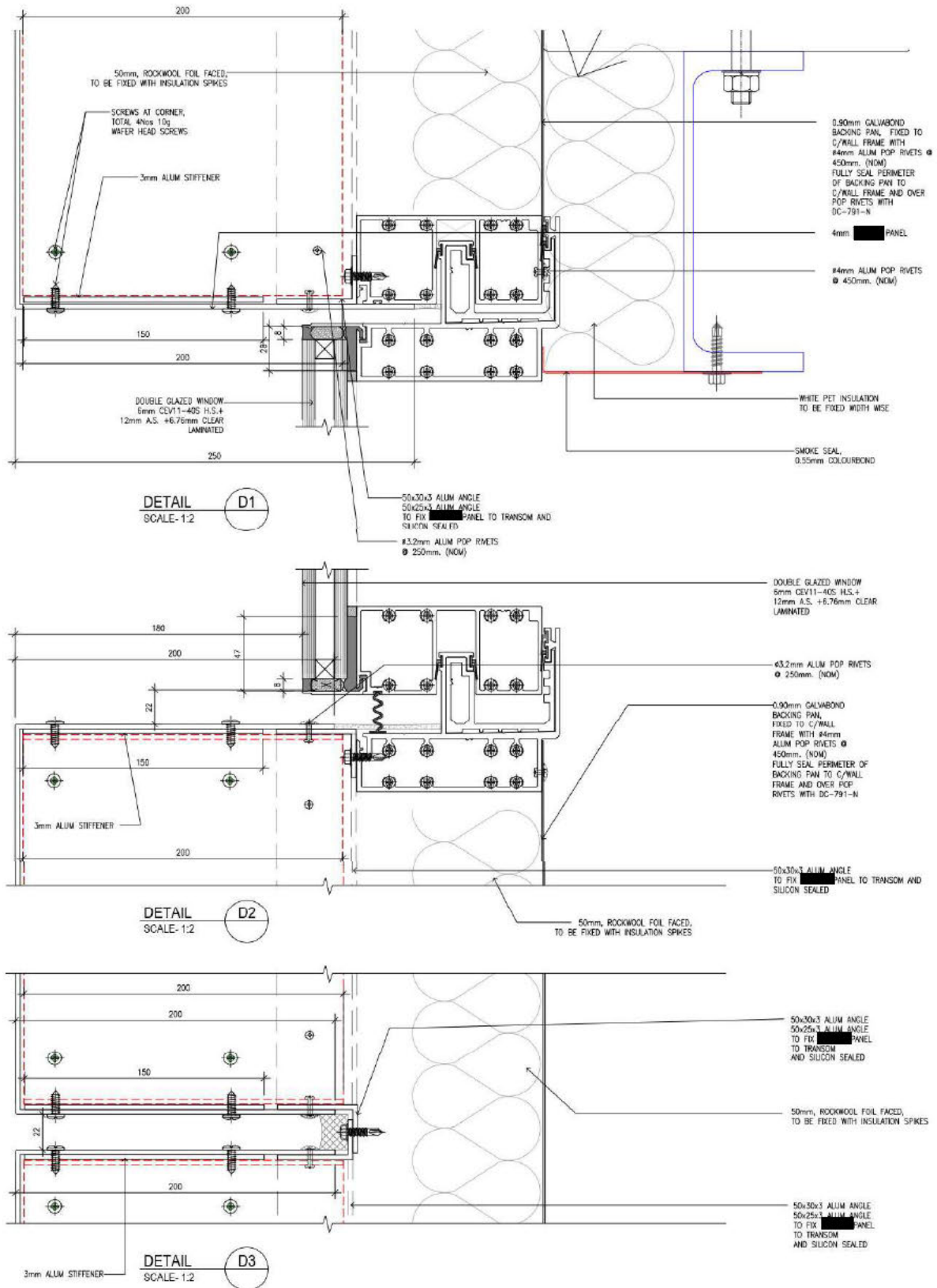

Figure 16 System assembly – Vertical cross-sectional view.

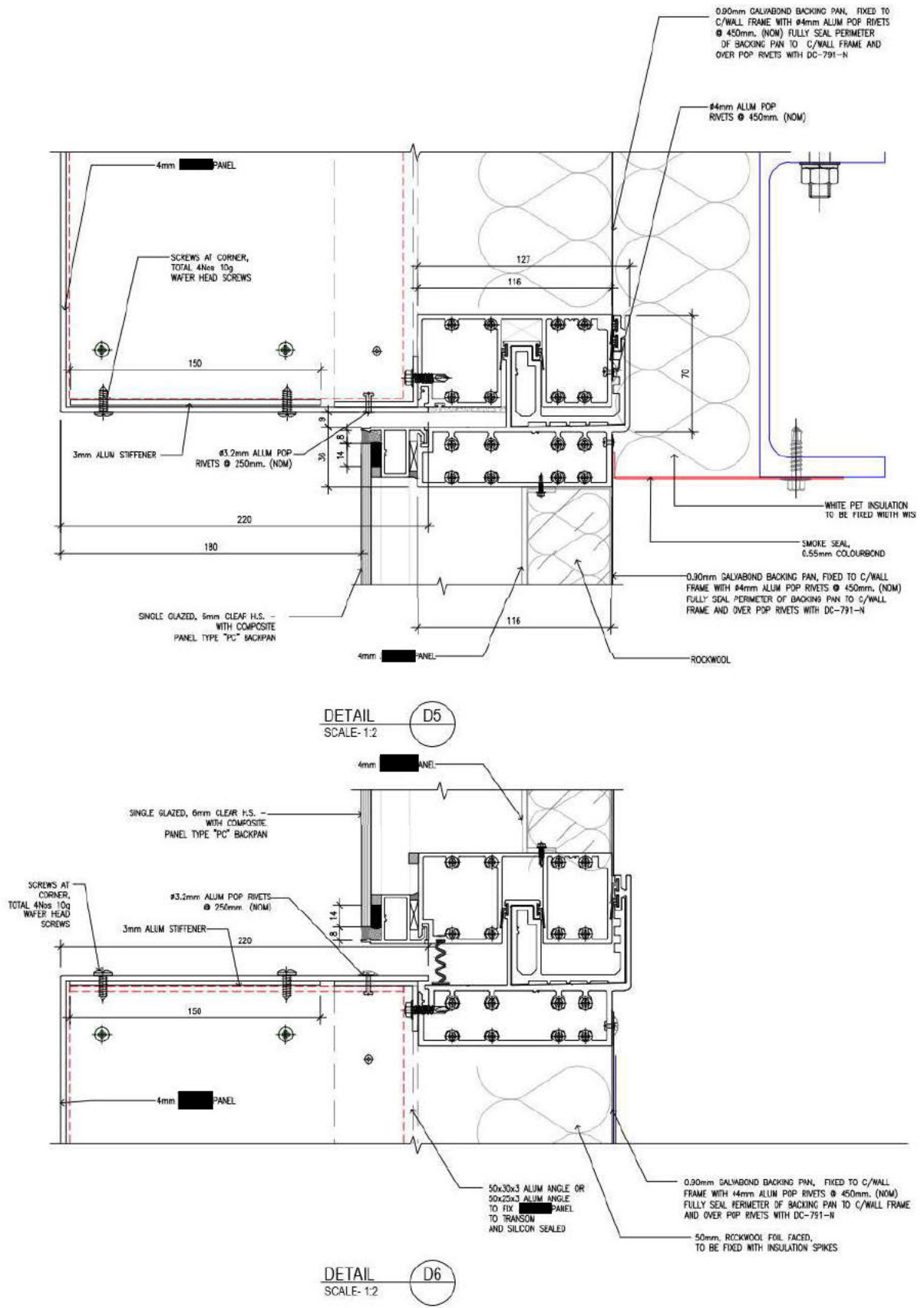

Figure 17 System assembly – Vertical cross-sectional view.

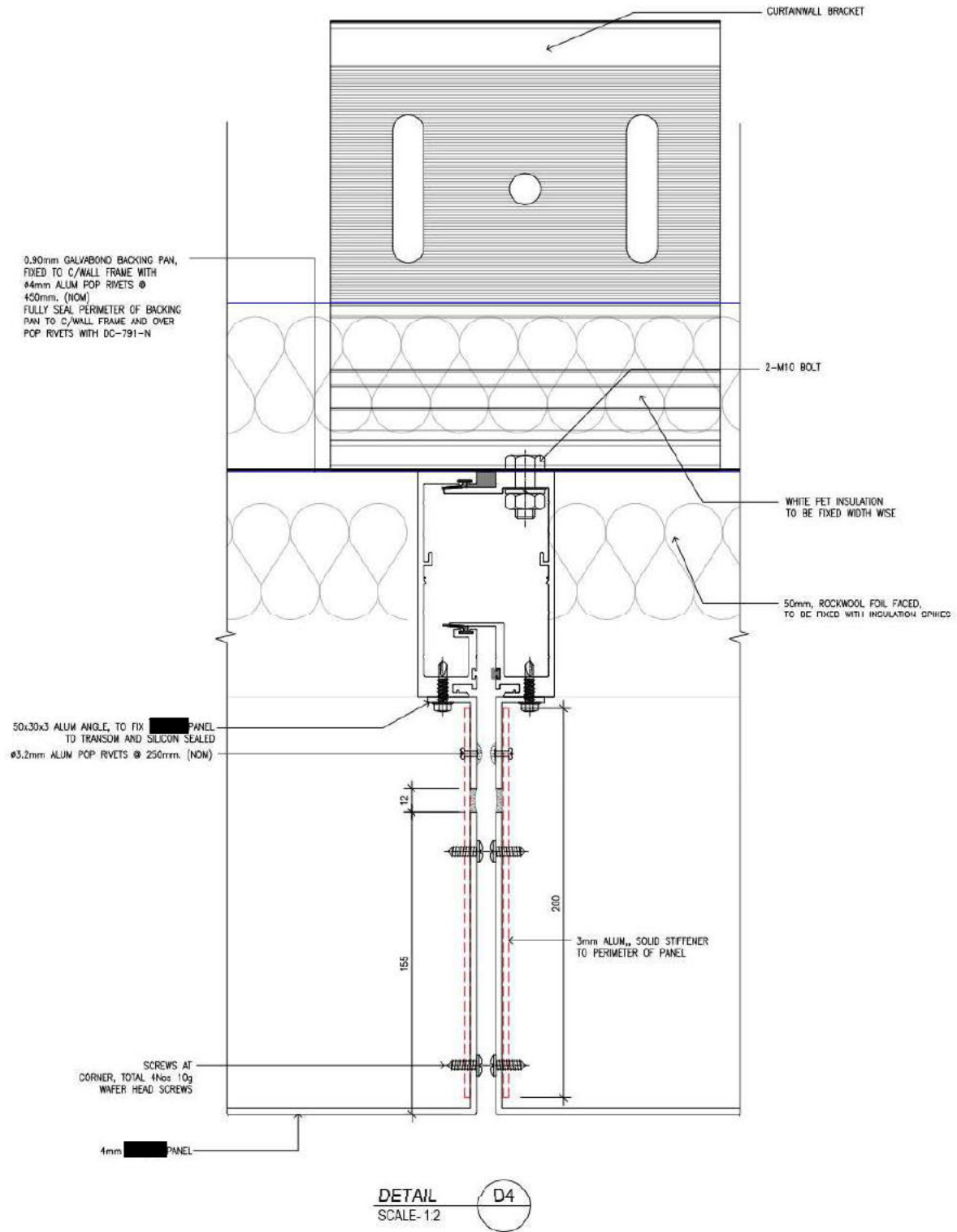

Figure 18 System assembly – horizontal cross-sectional view.

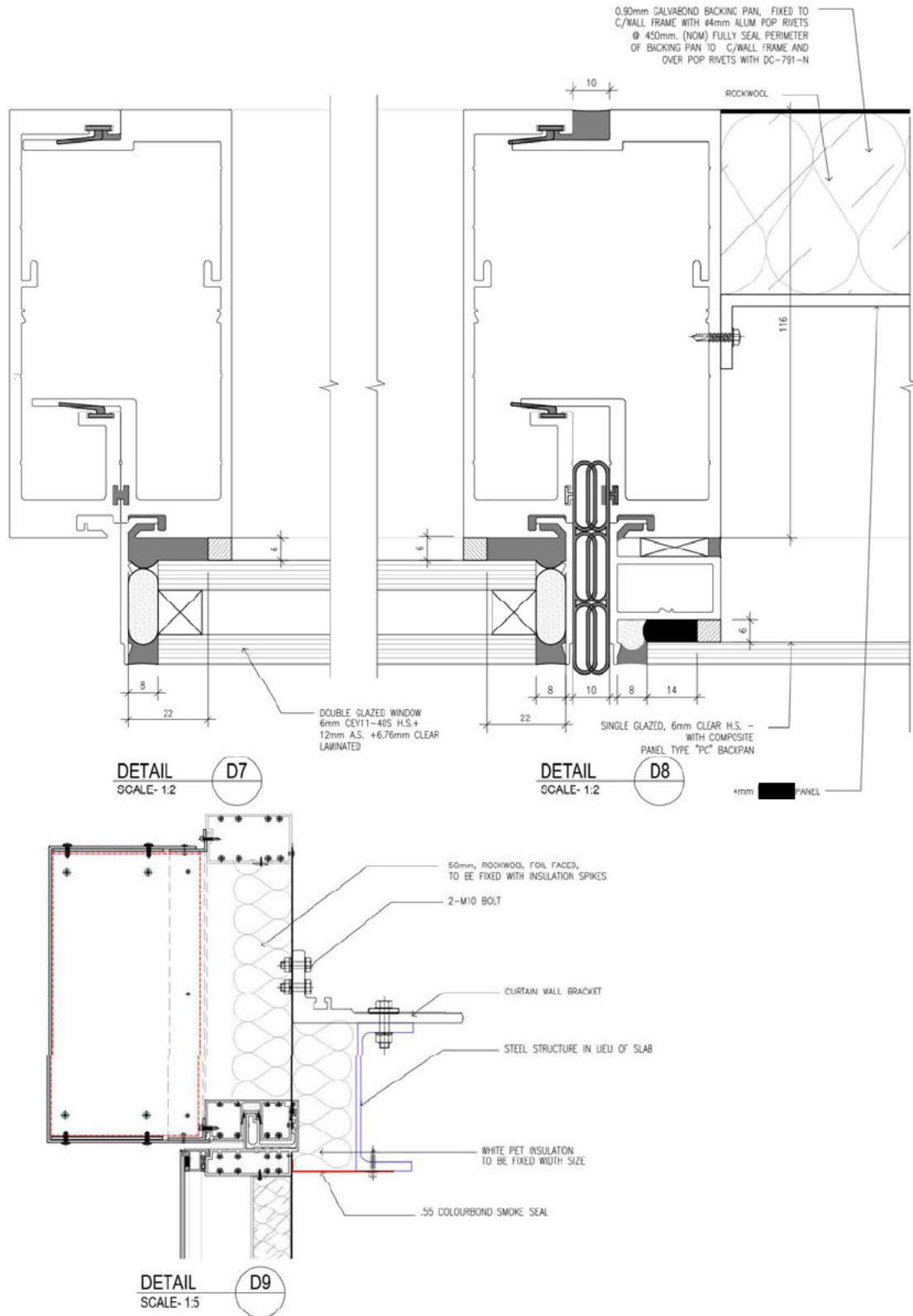

Figure 19 System assembly – vertical cross-sectional view.

Appendix B Photographs



Figure 20 The specimen (exposed side) before the reaction to fire test



Figure 21 The specimen (unexposed side) before the reaction to fire test



Figure 22 The specimen (angled - exposed side) before the reaction to fire test



Figure 23 The specimen 47 seconds into the test (burner output at 300 kW)



Figure 24 The specimen 2 minutes 18 seconds into the test (burner output at 300 kW)



Figure 25 The specimen 2 minutes 41 seconds into the test (burner output at 300 kW)



Figure 26 The specimen 3 minutes 52 seconds into the test (burner output at 300 kW)

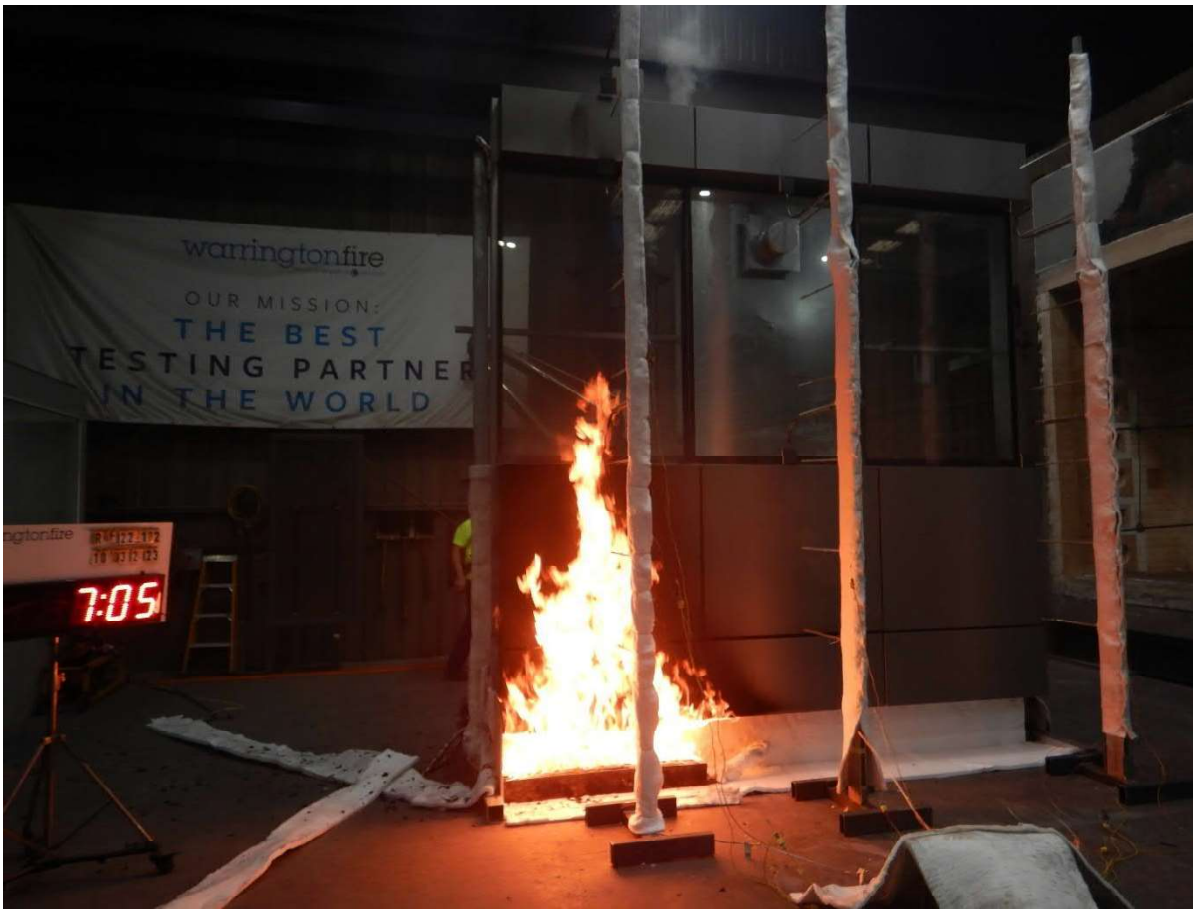

Figure 27 The specimen 7 minutes 5 seconds into the test (burner output at 300 kW)



Figure 28 The specimen 7 minutes 47 seconds into the test (burner output at 300 kW)

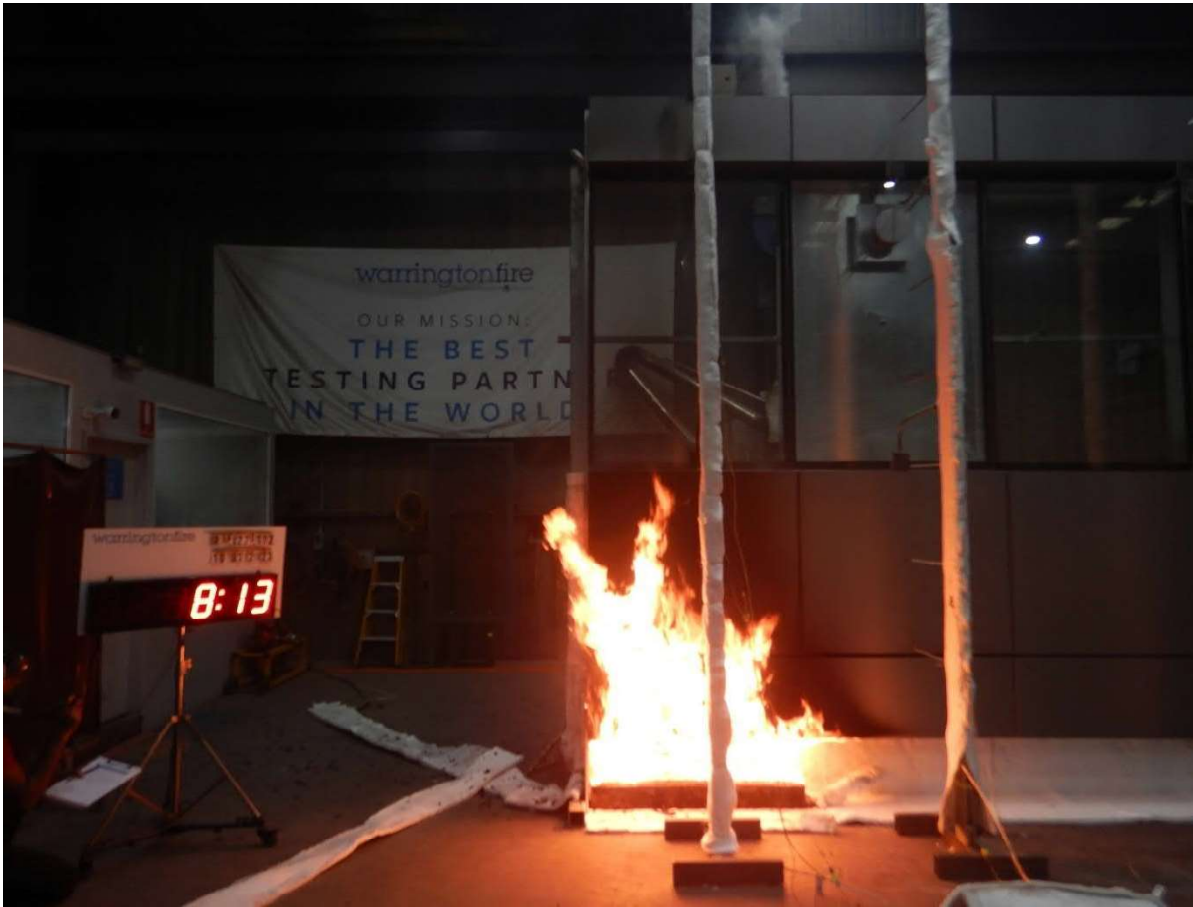

Figure 29 The specimen 8 minutes 13 seconds into the test (burner output at 300 kW)



Figure 30 The specimen 10 minutes 23 seconds into the test (burner output at 300 kW)



Figure 31 The specimen 11 minutes 6 seconds into the test (burner output at 300 kW)



Figure 32 The specimen 13 minutes 27 seconds into the test (burner output at 300 kW)



Figure 33 The specimen 14 minutes 3 seconds into the test (burner output at 300 kW)



Figure 34 The specimen 15 minutes 4 seconds into the test (burner output at 300 kW)



Figure 35 The specimen 16 minutes 57 seconds into the test (burner output at 300 kW)



Figure 36 The specimen 18 minutes 12 seconds into the test (burner output at 300 kW)



Figure 37 The specimen 20 minutes into the test (burner output at 300 kW)

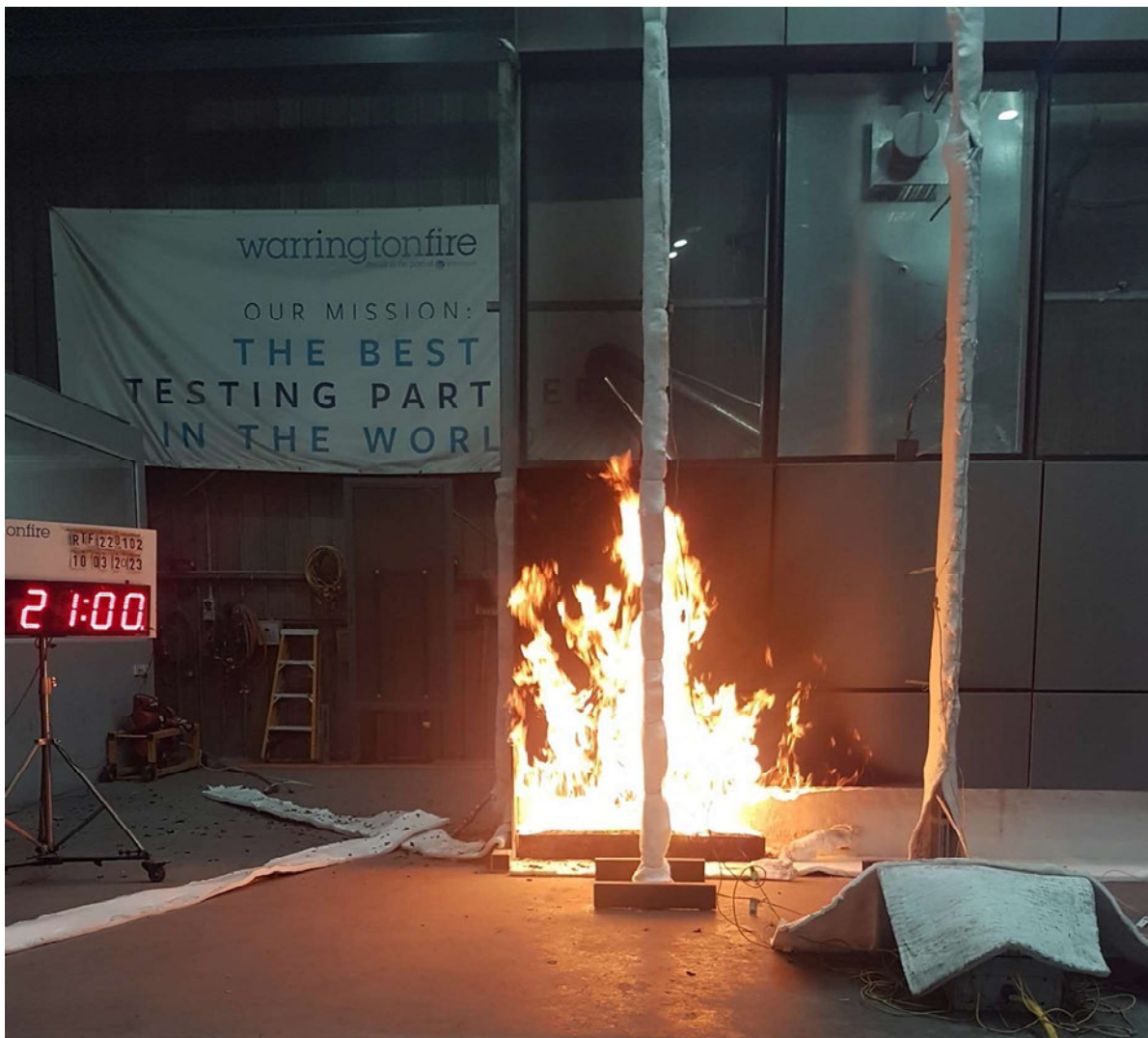

Figure 38 The specimen 21 minutes into the test (burner output at 300 kW)



Figure 39 The specimen 21 minutes 9 seconds into the test (burner output at 300 kW)



Figure 40 The specimen 21 minutes 41 seconds into the test (burner output at 300 kW)



Figure 41 The specimen 22 minutes 29 seconds into the test (burner output at 300 kW)



Figure 42 The specimen 23 minutes 5 seconds into the test (burner output at 300 kW)



Figure 43 The specimen 24 minutes 41 seconds into the test (burner output at 300 kW)



Figure 44 The specimen 25 minutes into the test (burner output at 300 kW)



Figure 45 The specimen 25 minutes 39 seconds into the test (burner output at 300 kW)



Figure 46 The specimen 26 minutes 32 seconds into the test (burner output at 300 kW)



Figure 47 The specimen 28 minutes 3 seconds into the test (burner output at 300 kW)



Figure 48 The specimen 28 minutes 1 second into the test (burner output at 300 kW) – unexposed side.



Figure 49 The specimen 29 minutes 7 seconds into the test (burner output at 300 kW) – unexposed side.



Figure 50 The specimen 29 minutes 10 seconds into the test (burner output at 300 kW)



Figure 51 The specimen 29 minutes 38 seconds into the test (burner output at 300 kW) – unexposed side.



Figure 52 The specimen 30 minutes into the test - burner turned off.



Figure 53 The specimen 30 minutes 45 seconds into the test (burner off).



Figure 54 The specimen 33 minutes 2 seconds into the test (burner off).



Figure 55 The specimen 34 minutes 29 seconds into the test (burner off).



Figure 56 The specimen 35 minutes 8 seconds into the test (burner off).



Figure 57 The specimen 36 minutes 46 seconds into the test (burner off).



Figure 58 The specimen 40 minutes 54 seconds into the test (burner off).



Figure 59 The specimen 43 minutes 11 seconds into the test (burner off).



Figure 60 The specimen at end of test – exposed side.

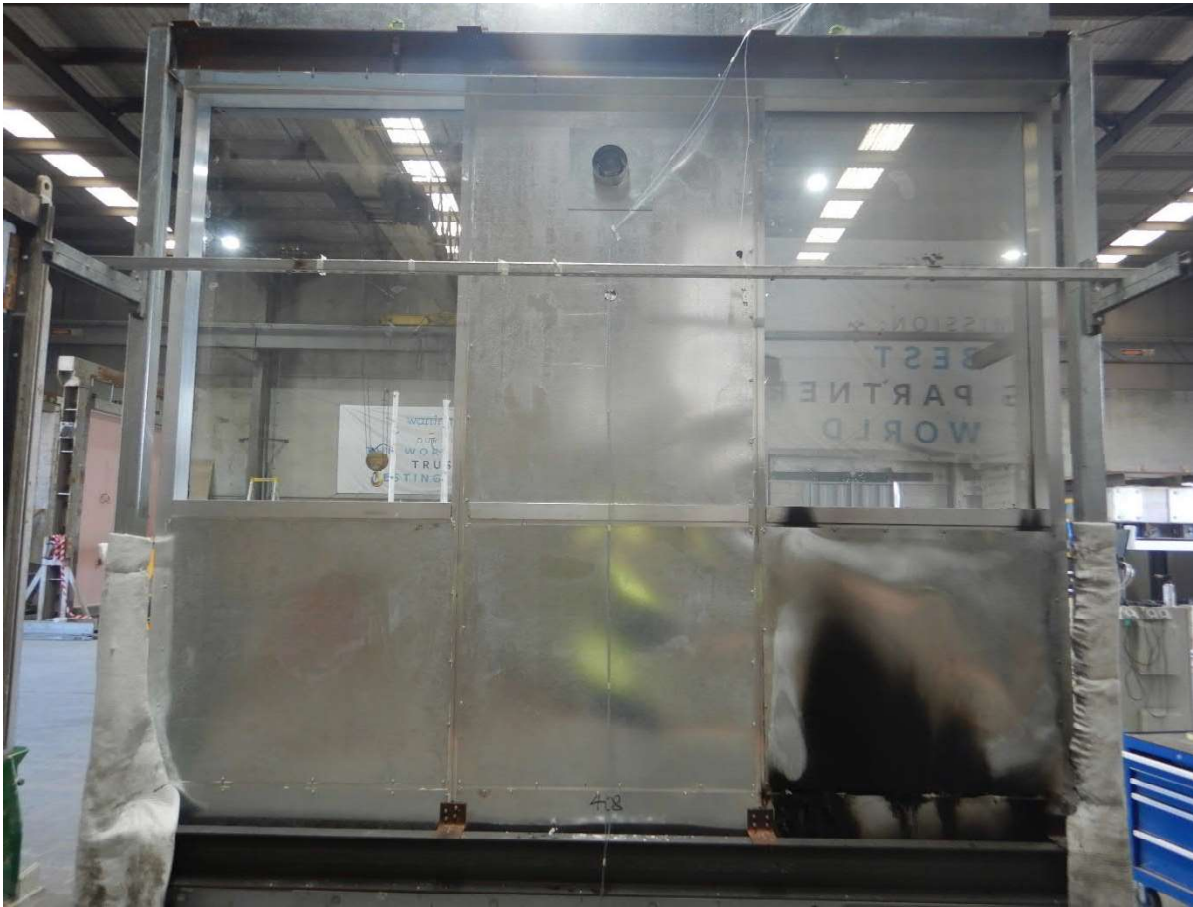

Figure 61 The specimen at end of test – unexposed side.

Appendix C Chemical Analysis Results

Mineral content	Report No.: 22155	Site sample #1 Report No.: 202212	Site sample #2 Report No.: 202212
	Composition of the ash - %		
Mineral content	46.7	47.2	47.1
Alumina	98.6	96.7	96.5
Sodium oxide	0.46	0.45	0.49
Iron oxide	<0.01	<0.01	<0.01
Titanium oxide	<0.01	<0.01	<0.01
Calcium oxide	0.02	<0.01	<0.01
Nickel oxide	<0.01	<0.01	<0.01
Magnesium oxide	0.20	0.21	0.21
Silica oxide	<0.01	<0.01	<0.01
Sulphur trioxide	<0.01	<0.01	<0.01
Phosphorous pentoxide	<0.01	<0.01	<0.01
Potassium oxide	<0.01	<0.01	<0.01
Zinc oxide	<0.01	<0.01	<0.01
Barium oxide	<0.01	<0.01	<0.01
Manganese oxide	<0.01	<0.01	<0.01
Copper oxide	<0.01	<0.01	<0.01
Chromium oxide	<0.01	<0.01	<0.01
Lead oxide	<0.01	<0.01	<0.01
Loss on ignition (1050 °C)	Not determined due to insufficient mass of ash		

Global locations



Warringtonfire Australia Pty Ltd
ABN 81 050 241 524

Perth

Suite 4.01, 256 Adelaide Terrace
Perth WA 6000
Australia
T: +61 8 9382 3844

Canberra

Unit 10, 71 Leichhardt Street
Kingston ACT 2604
Australia
T: +61 2 6260 8488

Melbourne

WeWork Level 4, 152 Elizabeth Street
Melbourne VIC 3000
Australia
T: +61 3 9767 1000

Sydney

Suite 802, Level 8, 383 Kent Street
Sydney NSW 2000
Australia
T: +61 2 9211 4333

Brisbane

Suite B Level 6, 133 Mary Street
Brisbane QLD 4000
Australia
T: +61 7 3238 1700

Melbourne – NATA accredited laboratory

409-411 Hammond Road
Dandenong South VIC 3175
Australia
T: +61 3 9767 1000